

SPRING COMPRESSOR

Apparecchio professionale per personale specializzato
Professional instrument for qualified personnel

By SEMAD TOOLS

SIMPLY HERCULES 2



SIMPLY HERCULES 1

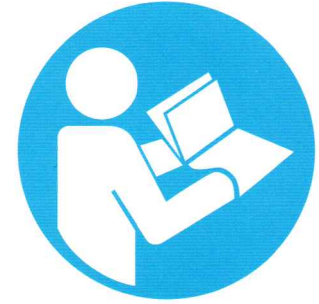

SIMPLY MEK



ORIGINAL INSTRUCTIONS



www.semadtools.com

SEMAD Srl
Regione Martin, 7
18020 DOLCEDO (IMPERIA - ITALIA)
Tel. +39 0183 281004 - Fax +39 0183 281835
semadtools@semadtools.com
Partita Iva: 01222790089
C.C.I.A.A. - Reg. Imp. IM2754/1999



Vers. A003.16

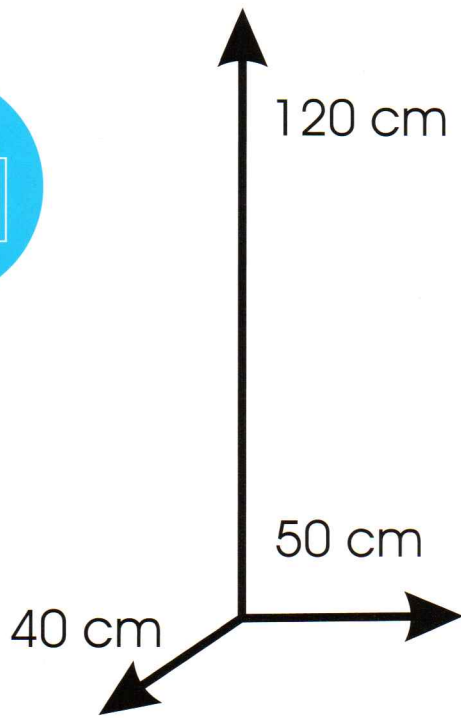

Simply Hercules 1

MIN 5 BAR - 600 Kg
MAX 10 BAR - 1200 Kg

Simply Hercules 2

MIN 5 BAR - 1200 Kg
MAX 10 BAR - 2400 Kg

Simply Mek

MAX 2400 Kg (60 Nm)

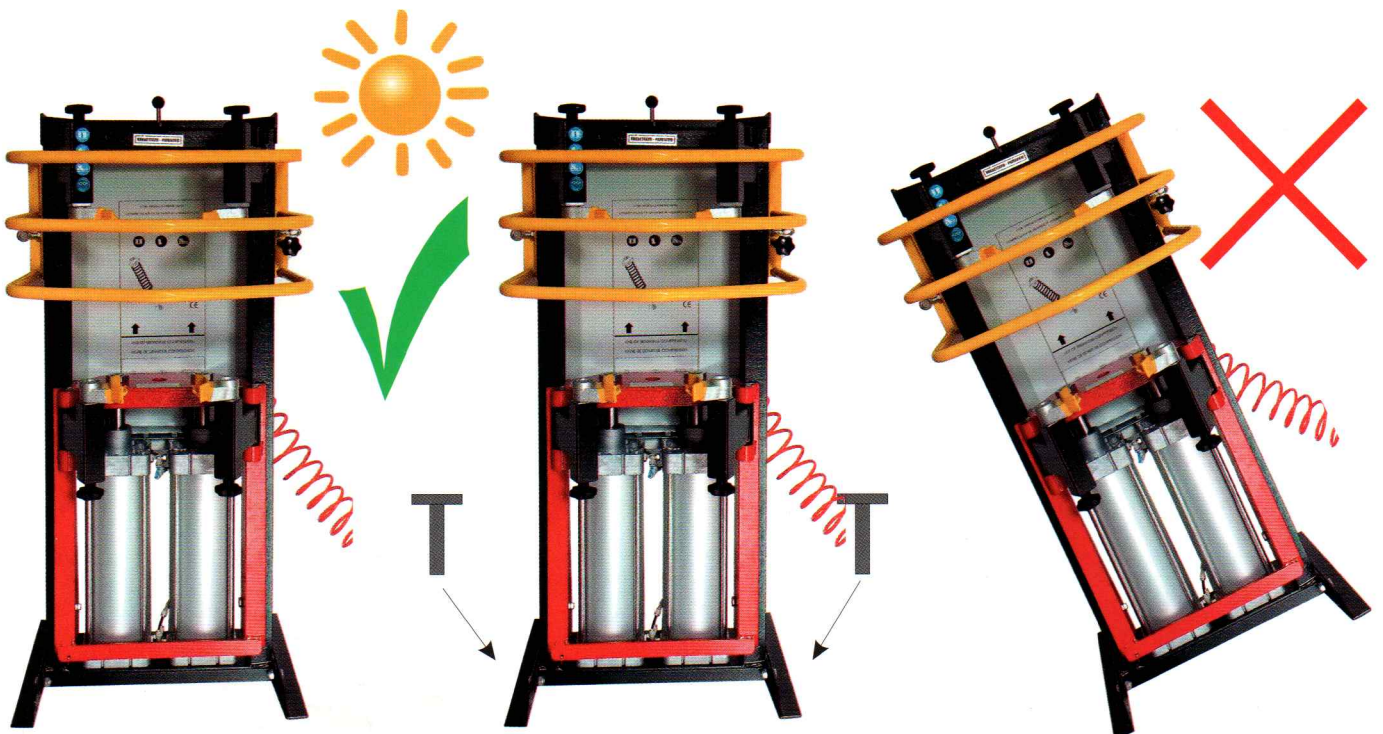
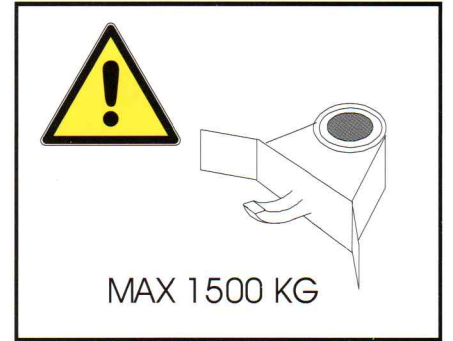
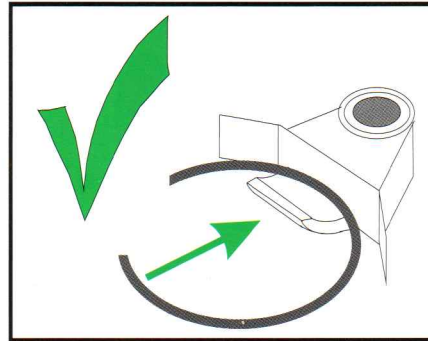
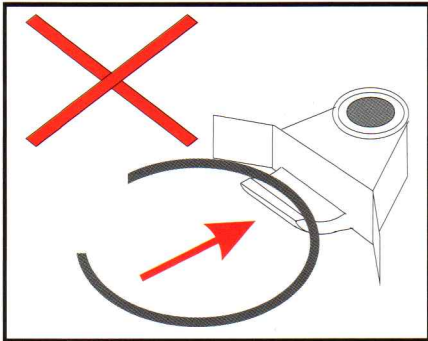

1

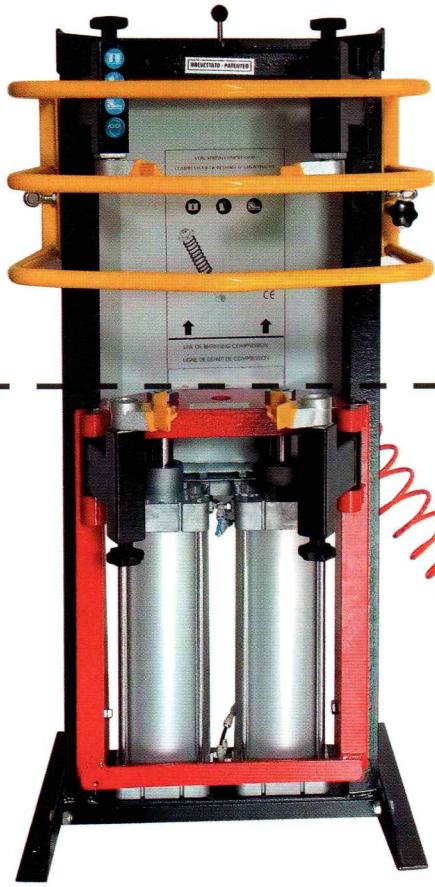

2

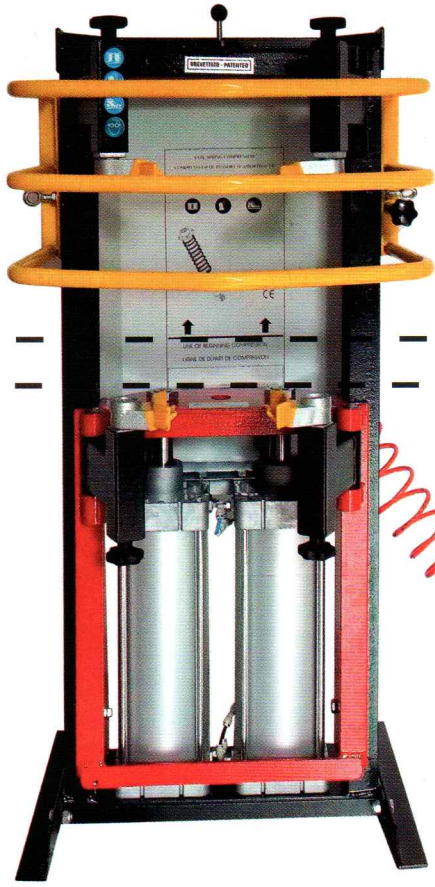

3

4

5

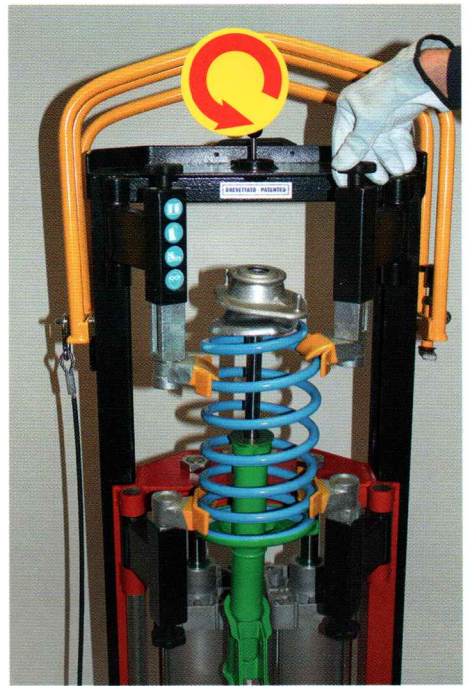
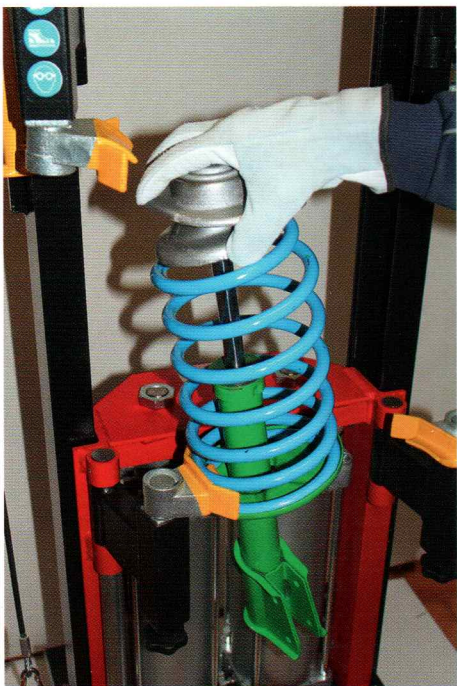

6

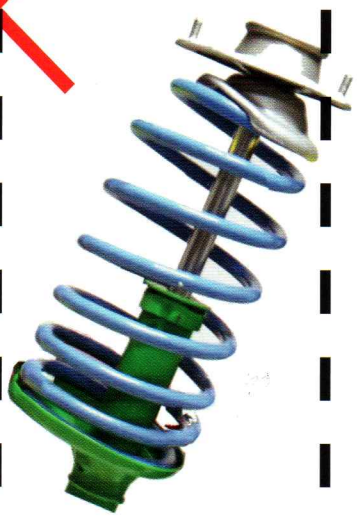
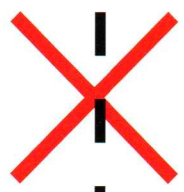

7

MEK

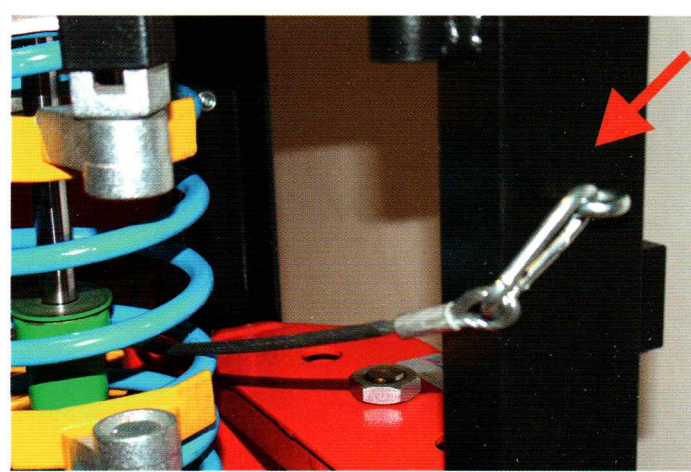
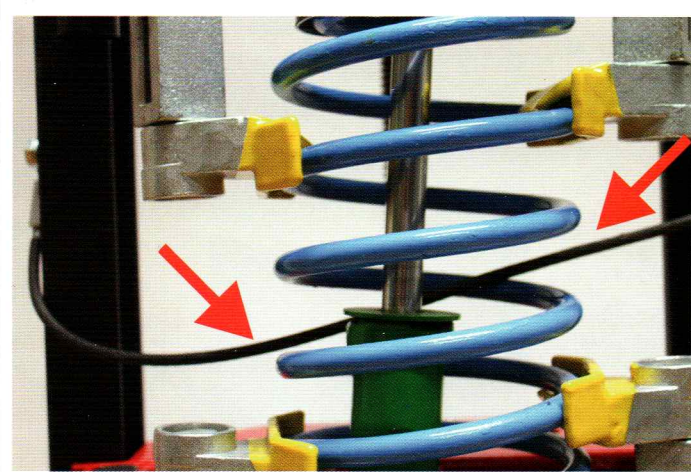

(optional)

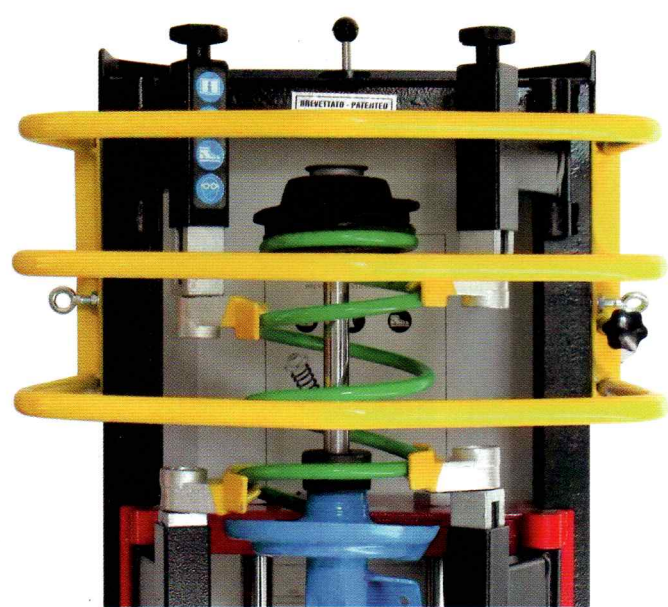

Simply Hercules 1 - 2

1

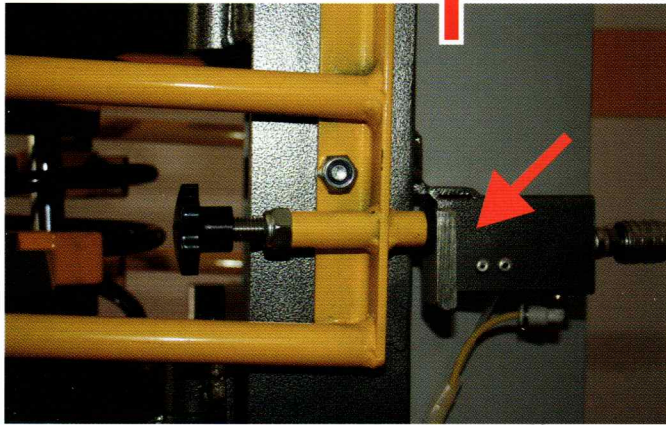

2

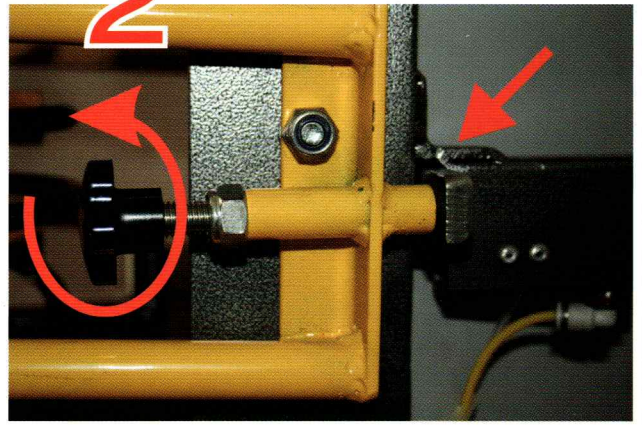

8

Simply Hercules 1 - 2

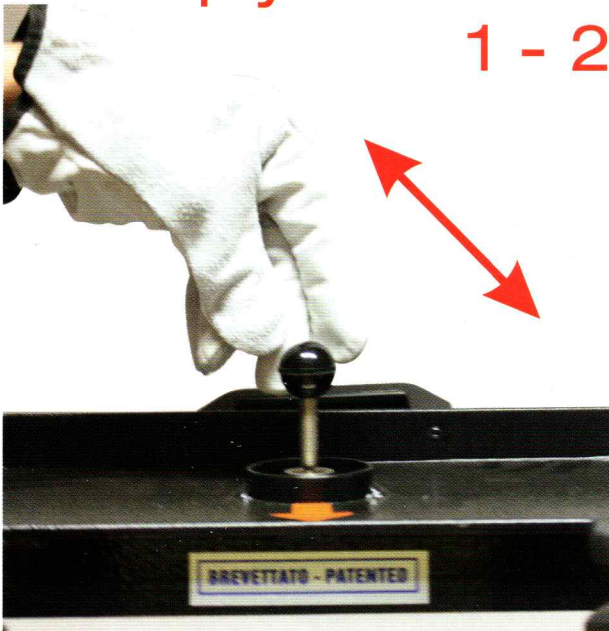

Simply Mek

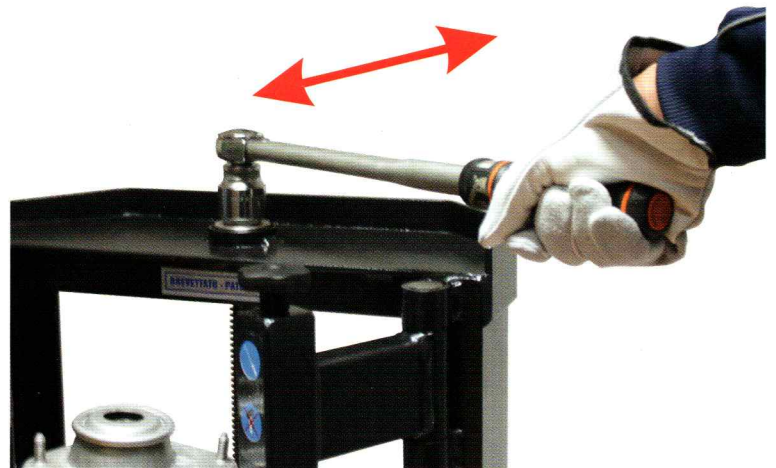

(optional)

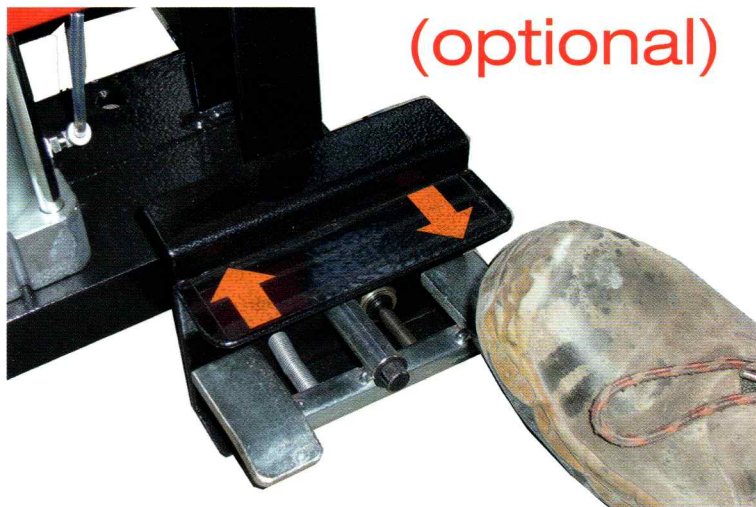

9

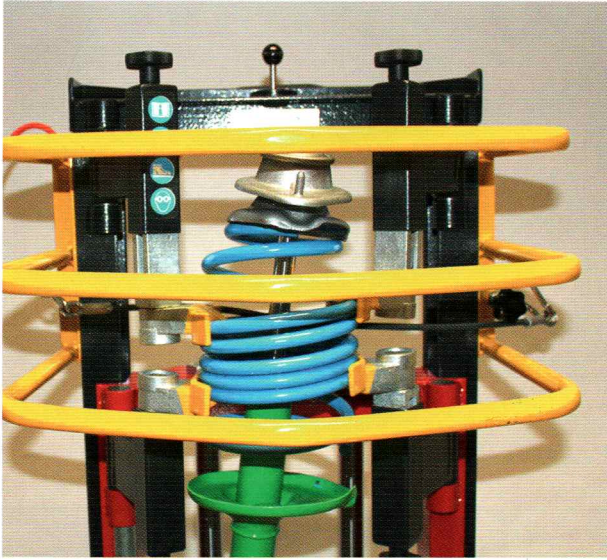

10

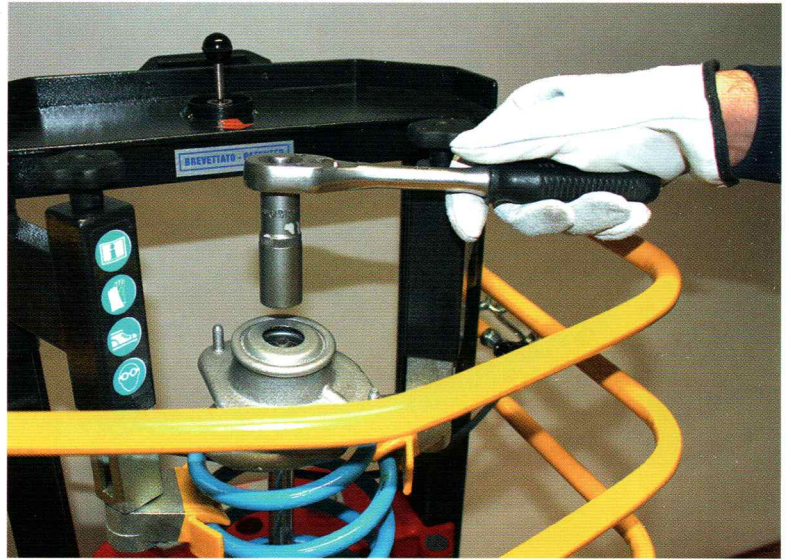

11

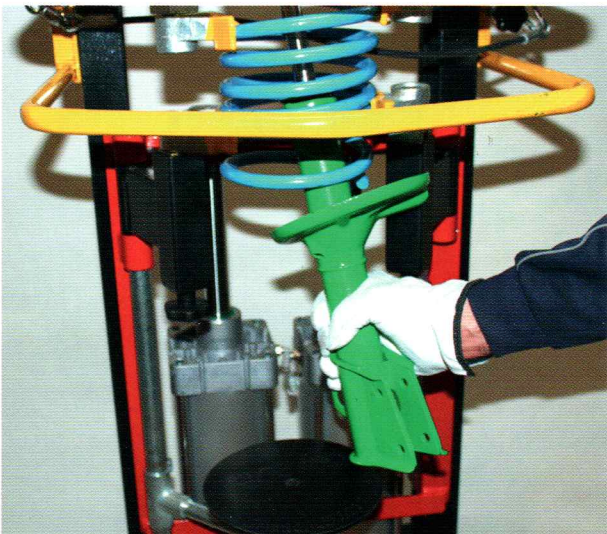

12

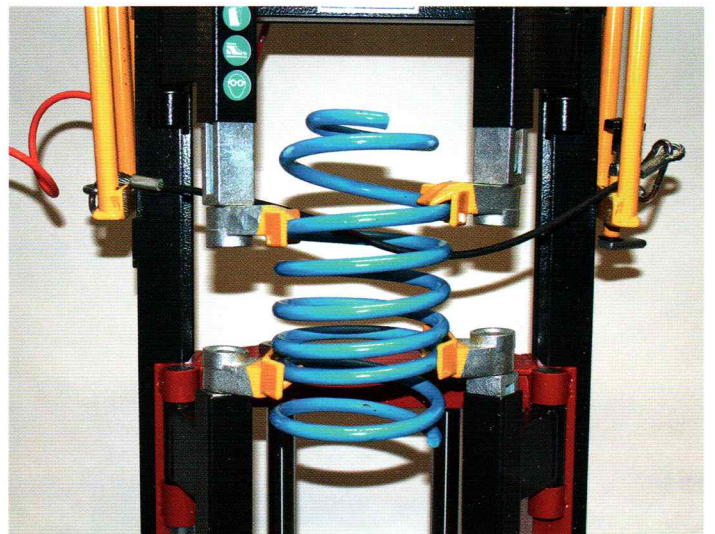

13

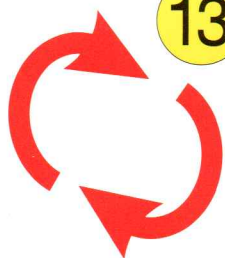

(optional)

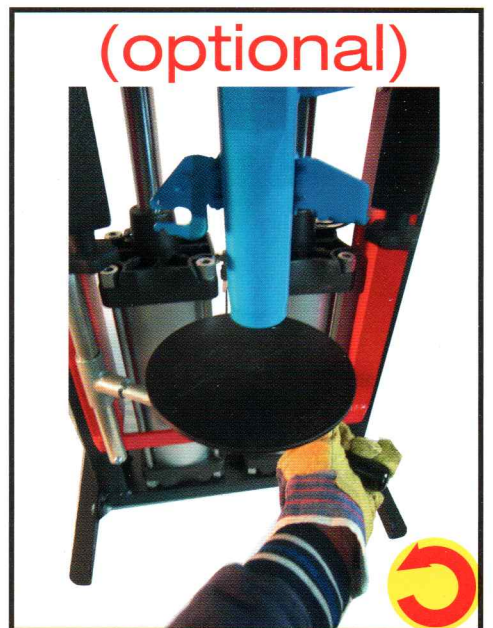

SPARE PARTS

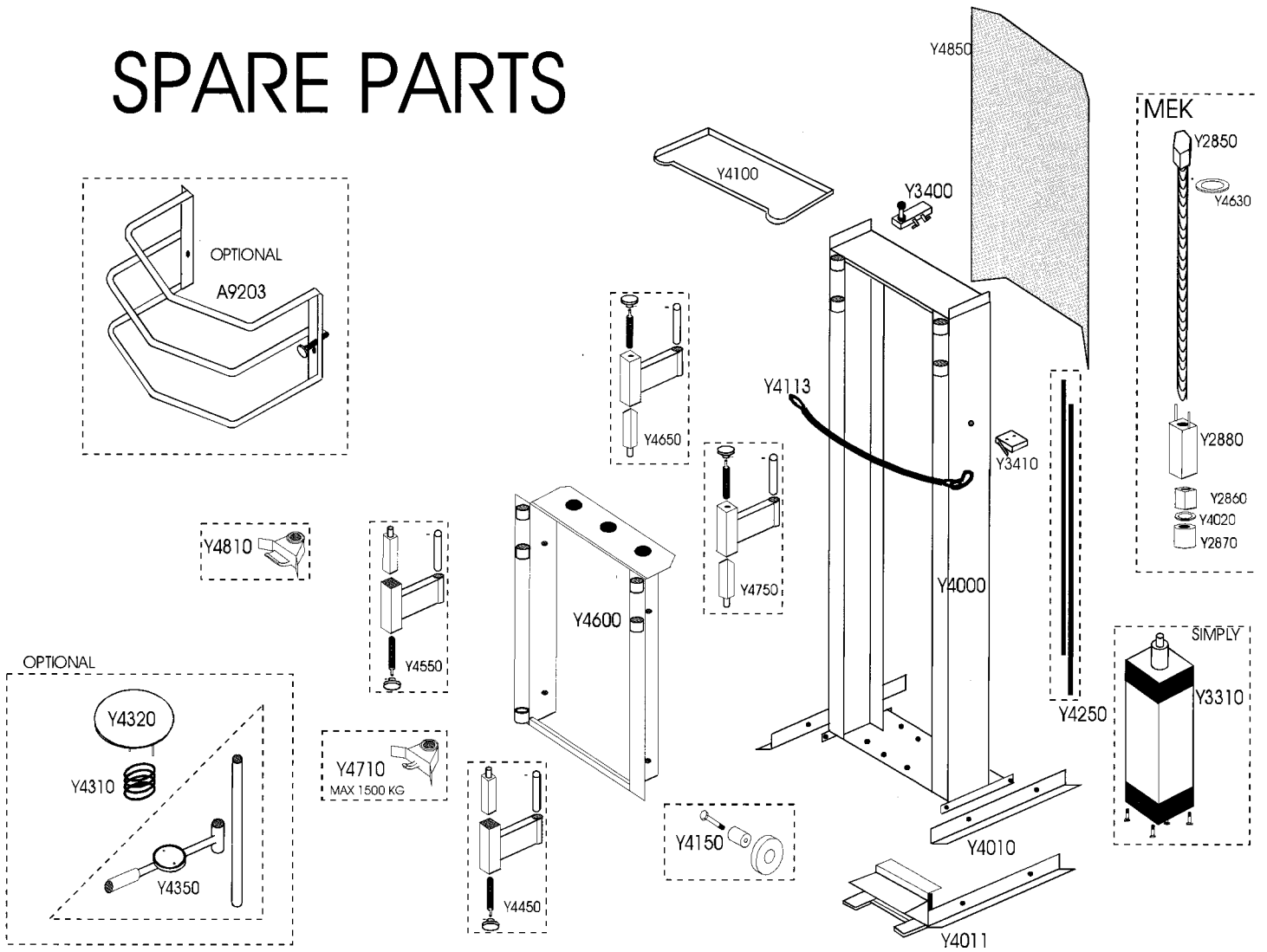

OPTIONAL

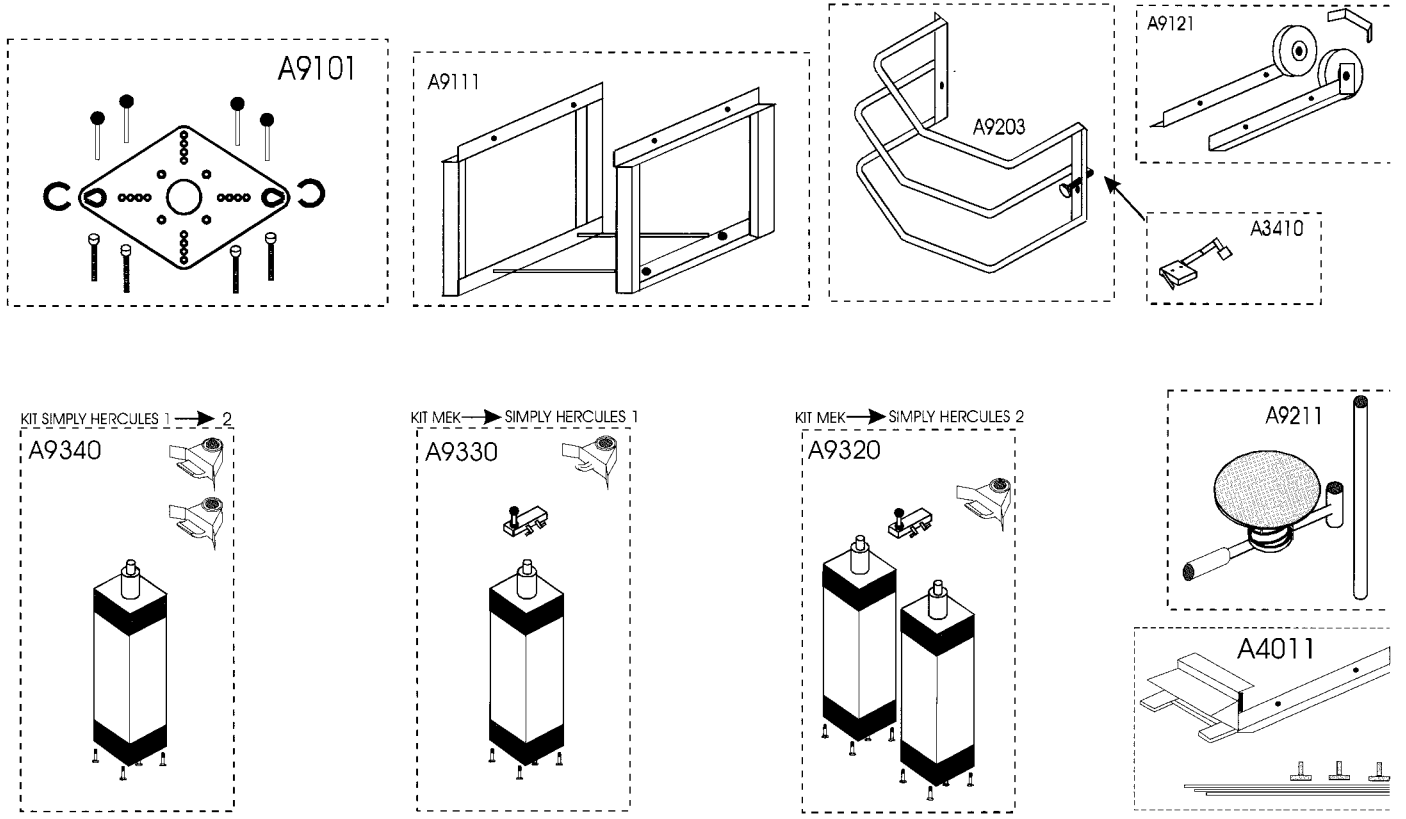

**DICHIARAZIONE DI CONFORMITA' CE DEL COSTRUTTORE
DECLARATION OF COMPLIANCE CE OF THE MANUFACTURER
CE KONFORMITÄTS ERKLÄRUNG DES HERSTELLER
DECLARATION DE CONFORMITE CE DU CONSTRUCTEUR
DECLARACION DE CONFORMIDAD CE DEL CONSTRUCTOR**

La sottoscrittore: SEMAD S.r.l.
The undersigned: Regione Martin, 7
Die unterzeichnete: 18020
La soussignée: DOLCEDO (IM)
La subscrita: ITALY

Dichiara che lo: SMONTA AMMORTIZZATORE UNIVERSALE
Declares that the: SHOCK ABSORBER DISMANTLER
Erklärt dass der: ZERLEGER FÜR DIE STOSSDAMPFER
Declare que le: DEMONTEUR POUR AMORTISSEURS
Declara que el: DESMONTA AMORTIGUADOR DE AUTOMATIZACION

Tipo: SIMPLY
Type:
Typ:
Type:
Tipo:

Modello: HERCULES 1
Model: HERCULES 2
Modell: MEK
Modele:
Modelo:

E' conforme alle disposizioni contenute nelle Direttive:
Is in compliance with the rules contained in the Directives:
Ist konform mit den Directiven:
Est conforme aux dispositions contenues dans les Directives:
Está conforme a las disposiciones contenidas en las Directivas:

- 2006/42/EC -

SEMAD s.r.l. unipersonale
Regione Martin, 7 - 18024 DOLCEDO (IM)
Cap. Soc. € 25.500,00
C.C.I.A.A. Reg. Imprese n. IM2754/1998
Partita IVA n. 01222790089
Tel. 0183.281004 - Fax 0183.281835

La documentazione relativa al Fascicolo Tecnico è conservata presso la:
Semad s.r.l. in Regione Martin 7 - 18020 Dolcedo (IM)