

OPERATOR'S MANUAL







EVOTORQUE® BATTERY TOOL (EBT)



READ OPERATOR'S MANUALS



Product	Model	Image	Operator's Manual
EvoTorque® Battery Tool (EBT series)	EBT #180XXX		#34464 (EN)
EvoTorque® Battery Pack (EBP series)	EBP #60334		#34466 (EN)
EvoTorque® Battery Charger (CTC123)	#CTC123 (60335)		#34468 (EN)

EN	English	Operator's Manual	Original Instructions	 #34464 + #34466 + #34468  www.norbar.com/en-gb/Downloads/Manuals
DA	Dansk / Danish	Betjeningsvejledning	Oversættelse af oprindelige instruktioner	
NL	Nederlands / Dutch	Handleiding	Vertaling Van De Originele Instructies	
FI	Suomi / Finnish	Käyttäjän opas	Käännös a lkuperäisistä ohjeista	
FR	Français / French	Manuel d'utilisation	Traduction des instructions originales	
DE	Deutsch / German	Bedienungsanleitung	Übersetzung der Originalanweisungen	
IT	Italiano / Italian	Manuale d'uso	Traduzione delle istruzioni originali	
NO	Norsk / Norwegian	Manual for maskinoperatør	Oversettelse av de originale instruksjonene	
PL	Polski / Polish	Instrukcja obsługi	Tłumaczenie oryginalnej instrukcji	
PT	Português / Portuguese	Manual do utilizador	Tradução das Instruções Originais	
ES	Español / Spanish	Manual del operario	Traducción de las instrucciones originales	
SV	Svenska / Swedish	Bruksanvisning	Översättning av bruksanvisning i original	

CONTENTS

Part Numbers Covered by This Manual	3
Bluetooth®	3
G400	4
Serial Number	5
Safety Messages	5
Safety – General Power Tool Safety Warnings	5
Work Area Safety	5
Electrical Safety	6
Personal Safety	6
Power Tool Use and Care	6
Battery Tool Use and Care	7
Service	7
Safety – EBT Specific Safety Warning	8
Markings on Tool	8
EBT Tools without Reaction Bar	8
Introduction	9
Parts Included	9
Accessories	10
Features and Functions	11
Set Up Instructions	13
Battery	13
Torque Reaction	14
Display Features	17
Setting Menu	17
Operating Instructions	19
Tightening	19
Saving Results	21
Releasing	21
Maintenance	22
Daily Checks	22
Calibration	22
Gearbox	23
Drive Square	23
Battery Maintenance	23
Battery Charger Maintenance	23
Product Disposal	23
Specifications	24
Symbol Specifications	24
Tool Specifications	24
USB Bluetooth® Smart Adapter	27
EU Declaration of Conformity	29
Troubleshooting	30
Glossary of Terms	32

PART NUMBERS COVERED BY THIS MANUAL

This manual covers the set up and use of Norbar EvoTorque® Battery Tools (EBT).

Bluetooth®:

Model	Torque Range	Speed	Orientation	Case	Part Number	
					Single Trigger & Bluetooth®	Safe to Start & Bluetooth®
EBT-52-800	160 – 800 N·m	1	IL	KIT	180850	180349
				BARE	180851	180350
			RA	KIT	180854	180353
				BARE	180855	180354
EBT-72-1350	200 – 1350 N·m	1	IL	KIT	180898	180445
				BARE	180899	180446
			RA	KIT	180902	180449
				BARE	180903	180450
	338 – 1350 N·m	2	IL	KIT	180922	180469
				BARE	180923	180470
			RA	KIT	180926	180473
				BARE	180927	180474
EBT-80-2700	400 – 2700 N·m	1	IL	KIT	180946	180541
				BARE	180947	180542
			RA	KIT	180950	180545
				BARE	180951	180546
	676 – 2700 N·m	2	IL	KIT	180970	180565
				BARE	180971	180566
			RA	KIT	180974	180569
				BARE	180975	180570
EBT-92-4000	800 – 4000 N·m	1	IL	KIT	180994	180637
				BARE	180995	180638
			RA	KIT	180998	180641
				BARE	180999	180642
	1000 – 4000 N·m	2	IL	KIT	181018	180661
				BARE	181019	180662
			RA	KIT	181022	180665
				BARE	181023	180666

G400:

Model	Torque Range	Speed	Orientation	Case	Part Number	
					Single Trigger & G400	Safe to Start & G400
EBT-52-800	160 – 800 N·m	1	IL	KIT	180858	180357
				BARE	180859	180358
			RA	KIT	180862	180361
				BARE	180863	180362
EBT-72-1350	200 – 1350 N·m	1	IL	KIT	180906	180453
				BARE	180907	180454
			RA	KIT	180910	180457
				BARE	180911	180458
	338 – 1350 N·m	2	IL	KIT	180930	180477
				BARE	180931	180478
			RA	KIT	180934	180481
				BARE	180935	180482
EBT-80-2700	400 – 2700 N·m	1	IL	KIT	180954	180549
				BARE	180955	180550
			RA	KIT	180958	180553
				BARE	180959	180554
	676 – 2700 N·m	2	IL	KIT	180978	180573
				BARE	180980	180574
			RA	KIT	180982	180577
				BARE	180983	180578
EBT-92-4000	800 – 4000 N·m	1	IL	KIT	181002	180645
				BARE	181003	180646
			RA	KIT	181006	180649
				BARE	181007	180650
	1000 – 4000 N·m	2	IL	KIT	181026	180669
				BARE	181027	180670
			RA	KIT	181030	180673
				BARE	181031	180674

**IMPORTANT: ALL EBT TOOLS ARE SUPPLIED WITH REACTION BAR
SPEED = 1 (SINGLE SPEED) OR 2 (AUTO TWO SPEED TO ALLOW FAST RUNDOWN)
ORIENTATION = IL (IN-LINE) OR RA (RIGHT ANGLE FOR 90°ACCESS)
CASE = KIT (TOOL HANDLE + 2 BATTERIES + 1 CHARGER + PLASTIC CARRY CASE) OR BARE (TOOL HANDLE ONLY + CARDBOARD CASE).**

NOTE: The main tool models are listed above; other tools with minor variances are also covered.

Serial Number

The serial number is in the following format: **YYYYAXXXXX**

Serial Number	Description	Options		
YYYY*****	Year of manufacture			
****A*****	Month of manufacture	A=January D= April G=July K=October	B= February E= May H=August L=November	C= March F=June J=September M=December
*****XXXXX	Serial number			

NOTE: Due to the manufacturing process, the calibration date may be after the month of manufacture.

SAFETY MESSAGES

The safety messages are provided to cover reasonable situations that may be encountered when operating, servicing or repairing cordless tools. It is the responsibility of operators and servicing technicians to be knowledgeable about the procedures, tools and materials used, and to satisfy themselves that the procedures, tools and materials will not compromise their safety, that of others in the work place or the tool.

Use only with Norbar EvoTorque® Battery Pack (EBP series) batteries.
Read EvoTorque® Battery Pack (EBP series) Operator's Manual #34466

Charge only with Norbar EvoTorque® Battery Charger (CTC / EBC Series) equipment.
Read EvoTorque® Battery Charger (CTC123 (60335)) Operator's Manual #34468

SAFETY – GENERAL POWER TOOL SAFETY WARNINGS

Symbol	Meaning
	The exclamation mark is intended to alert the user to the presence of important operating and maintenance (servicing) instructions in the manual.



WARNING: READ ALL SAFETY WARNINGS, INSTRUCTIONS, ILLUSTRATIONS AND SPECIFICATIONS PROVIDED WITH THIS POWER TOOL. FAILURE TO FOLLOW ALL INSTRUCTIONS LISTED BELOW MAY RESULT IN ELECTRIC SHOCK, FIRE AND/OR SERIOUS INJURY.

Save all warnings and instructions for future reference. The term "power tool" in the warnings refers to your mains-operated (corded) power tool or battery-operated (cordless) power tool.

Work Area Safety

- **Keep work area clean and well lit.** Cluttered or dark areas invite accidents.
- **Do not operate power tools in explosive atmospheres, such as in the presence of flammable liquids, gases or dust.** Power tools create sparks which may ignite the dust or fumes.
- **Keep children and bystanders away while operating a power tool.** Distractions can cause you to lose control.

Electrical Safety

- **Power tool plugs must match the outlet. Never modify the plug in any way. Do not use any adapter plugs with earthed (grounded) power tools.** *Unmodified plugs and matching outlets will reduce risk of electric shock.*
- **Avoid body contact with earthed or grounded surfaces, such as pipes, radiators, ranges and refrigerators.** *There is an increased risk of electric shock if your body is earthed or grounded.*
- **Do not expose power tools to rain or wet conditions.** *Water entering a power tool will increase the risk of electric shock.*
- **Do not abuse the cord. Never use the cord for carrying, pulling or unplugging the power tool. Keep cord away from heat, oil, sharp edges or moving parts.** *Damaged or entangled cords increase the risk of electric shock.*
- **When operating a power tool outdoors, use an extension cord suitable for outdoor use.** *Use of a cord suitable for outdoor use reduces the risk of electric shock.*
- **If operating a power tool in a damp location is unavoidable, use a residual current device (RCD) protected supply.** *Use of an RCD reduces the risk of electric shock.*

Personal Safety

- **Stay alert, watch what you are doing and use common sense when operating a power tool. Do not use a power tool while you are tired or under the influence of drugs, alcohol or medication.** *A moment of inattention while operating power tools may result in serious personal injury.*
- **Use personal protective equipment (PPE). Always wear eye protection.** *Protective equipment such as a dust mask, non-skid safety shoes, hard hat or hearing protection used for appropriate conditions will reduce personal injuries.*
- **Prevent unintentional starting. Ensure the switch is in the off-position before connecting to power source and/or battery pack, picking up or carrying the tool.** *Carrying power tools with your finger on the switch or energising power tools that have the switch on invites accidents.*
- **Remove any adjusting key or wrench before turning the power tool on.** *A wrench or a key left attached to a rotating part of the power tool may result in personal injury.*
- **Do not overreach. Keep proper footing and balance at all times.** *This enables better control of the power tool in unexpected situations.*
- **Dress properly. Do not wear loose clothing or jewellery. Keep your hair and clothing away from moving parts.** *Loose clothes, jewellery or long hair can be caught*
- **If devices are provided for the connection of dust extraction and collection facilities, ensure these are connected and properly used.** *Use of dust collection can reduce dust-related hazards.*
- **Do not let familiarity gained from frequent use of tools allow you to become complacent and ignore tool safety principles.** *A careless action can cause severe injury within a fraction of a second.*

Power Tool Use and Care

- **Do not force the power tool. Use the correct power tool for your application.** *The correct power tool will do the job better and safer at the rate for which it was designed.*
- **Do not use the power tool if the switch does not turn it on and off.** *Any power tool that cannot be controlled with the switch is dangerous and must be repaired.*
- **Disconnect the plug from the power source and/or remove the battery pack, if detachable, from the power tool before making any adjustments, changing accessories, or storing power tools.** *Such preventive safety measures reduce the risk of starting the power tool accidentally.*

- **Store idle power tools out of the reach of children and do not allow persons unfamiliar with the power tool or these instructions to operate the power tool.** *Power tools are dangerous in the hands of untrained users.*
- **Maintain power tools and accessories. Check for misalignment or binding of moving parts, breakage of parts and any other condition that may affect the power tool's operation. If damaged, have the power tool repaired before use.** *Many accidents are caused by poorly maintained power tools.*
- **Keep cutting tools sharp and clean.** *Properly maintained cutting tools with sharp cutting edges are less likely to bind and are easier to control.*
- **Use the power tool, accessories and tool bits etc. in accordance with these instructions, taking into account the working conditions and the work to be performed.** *Use of the power tool for operations different from those intended could result in a hazardous situation.*
- **Keep handles and grasping surfaces dry, clean and free from oil and grease.** *Slippery handles and grasping surfaces do not allow for safe handling and control of the tool in unexpected situations.*

Battery Tool Use and Care

- **Recharge only with the charger specified by the manufacturer.** *A charger that is suitable for one type of battery pack may create a risk of fire when used with another battery pack.*
- **Use power tools only with specifically designated battery packs.** *Use of any other battery packs may create a risk of injury or fire.*
- **When battery pack is not in use, keep it away from other metal objects, like paper clips, coins, keys, nails, screws or other small metal objects, that can make a connection from one terminal to another.** *Shorting the battery terminals together may cause burns or a fire.*
- **Under abusive conditions, liquid may be ejected from the battery; avoid contact. If contact accidentally occurs, flush with water. If liquid contacts eyes, additionally seek medical help.** *Liquid ejected from the battery may cause irritation or burns.*
- **Do not use a battery pack or tool that is damaged or modified.** *Damaged or modified batteries may exhibit unpredictable behaviour resulting in fire, explosion or risk of injury.*
- **Do not expose a battery pack or tool to fire or excessive temperature.** *Exposure to fire or temperature above 120 °C (248 °F) may cause explosion.*
- **Follow all charging instructions and do not charge the battery pack or tool outside the temperature range specified in the instructions.** *Charging improperly or at temperatures outside the specified range may damage the battery and increase the risk of fire.*

Service



- **Have your power tool serviced by a qualified repair person using only identical replacement parts.** *This will ensure that the safety of the power tool is maintained.*
- **Never service damaged battery packs.** *Service of battery packs should only be performed by the manufacturer or authorized service providers.*

SAFETY – EBT SPECIFIC SAFETY WARNING

This tool is intended for use with threaded fasteners.

- It is recommended for the operator to wear hearing protection.
- Always use impact or high-quality sockets.
- Use only sockets and adaptors which are in good condition.
- Use only sockets and adaptors which are intended for use with power tools.
- Always operate with an approved reaction bar. Do not fix reaction bar to reaction point.
- Do not block cooling air entry and exit points.
- For very low torque rate joints (e.g. heat exchangers with long rundown threads) the tool will get warm. In extreme cases, the tool safety temperature control will stop the tool.
- Understand the operation of both the TORQUE target and the ANGLE target, especially when applied to pre-tightened fasteners. Incorrect tool use can easily apply excessive torque.
- Do not remove any labels. Replace all damaged labels.
- Do not lock or tape trigger, or 'safe to start' button, in the ON position.
- If the tool malfunctions, discontinue use and immediately arrange for service and repair.
- Do not lubricate or clean tools with flammable or volatile liquids such as kerosene, gasoline, diesel, or jet fuel.
- Store tool in carry case after use.
- When used for railway applications, the tool may not be used on or adjacent to electrically live conductor rails.

Markings on Tool

Pictograms on Tool	Meaning
	Read and understand Operator's Manual.
	Unexpected tool movement due to reaction forces or breakage of drive square or reaction bar may cause injuries. There is a risk of crushing between the reaction bar and work piece. Keep hands away from reaction bar. Keep hands away from tool output.

EBT Tools without a Reaction Bar

Upon customer request some EBT tools are supplied without a reaction bar. These tools **MUST NOT** be used until a suitable reaction bar has been fitted. The reaction bar is defined as 'interchangeable equipment' under the European directive 2006/42/EC on Machinery Safety. If applicable a new reaction bar will need to comply with this directive.

INTRODUCTION







The EvoTorque® Battery Tool (EBT) is an electronic torque tool designed for applying torque to threaded fasteners. There are models to cover torque capacities of 800 N·m to 4,000 N·m.

Parts Included

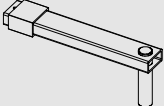
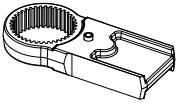
Kit or Bare	Case type:	Contents:
Kit	Plastic carry case	Tool handle 2 x Battery (Part EBP 60334.EBT) Charger (Part CTC123 (60335.KIT)) (Additional items listed in below table)
Bare	Cardboard case	Tool handle only (Additional items listed in below table)

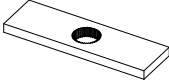
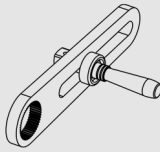
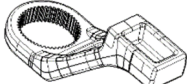
Description	Model			
	EBT-52	EBT-72	EBT-80	EBT-92
Maximum Torque	800 N·m	1,350 N·m	2,700 N·m	4,000 N·m
Visual Difference (1 speed / In-Line shown)				
Steel Reaction Bars	18646	19289	19289	19291
Reaction Bar Retaining Circlip	26588	26486	26486	26486
Drive Square (fitted)	18544	18492 (1")	19431 (1")	18934 (1")
Drive Square (spare)	18544	18779 (¾")	19431 (1")	18934 (1")
4 mm Hex Key for Drive Square	24953	24953	24953	24953
EBT Operator's Manual	34464	34464	34464	34464
USB memory stick with EvoLog PC software & Operator's Manual	61139	61139	61139	61139
USB lead (2 m)	39777	39777	39777	39777
USB Bluetooth® Smart adapter (where included)	43513	43513	43513	43513
Secondary Handle	-	19363	19448	19363

Accessories

Description	Model			
	EBT-52	EBT-72	EBT-80	EBT-92
¾" Drive Square (Fixing Screw)	18544 (25351.30)	18779 (25325.45)	-	-
1" Drive Square (Fixing Screw)	18545 (25351.30)	18492 (25352.45)	19431 (25352.40)	18934 (25352.60)
1 ½" Drive Square (Fixing Screw)	-	-	-	18935 (25352.60)
Reaction Bar (NOTE) 	18298	18298	-	-
Reaction Bar Adaptor (NOTE) 	18558	18290	-	-
Single-Sided Reaction Plate 	18576	18292	18292	18979
Double-Sided Reaction Plate 	18590	18293	18293	18980
Sliding Reaction Plate 	-	(¾") 180300.072.B06 (1") 180300.072.B08	180300.080.B08	(¾") 180300.092.B06 (1") 180300.092.B08
 Aluminium Cranked Reaction Foot	-	18494	18494	18936
6" Blade Nose Extension	(¾") (18601.006)	(1") 18755.006	-	-
9" Blade Nose Extension	(¾") (18601.009)	(1") 18755.009	-	-
12" Blade Nose Extension	(¾") (18601.012)	(1") 18755.012	-	-
9" Nose Extension for Truck and Bus Wheels	-	(¾") 19087.009 (1") 19089.009	-	-
12" Nose Extension for Truck and Bus Wheels	-	(¾") 19087.012 (1") 19089.012	-	-
Battery 	EBP 60334	EBP 60334	EBP 60334	EBP 60334
Secondary Handle 	-	19363	19448	19363
Charger 	CTC123 (60335)	CTC123 (60335)	CTC123 (60335)	CTC123 (60335)

NOTE: Requires both "Reaction Bar" and "Reaction Bar Adaptor" to be used together.

Reactions to suit specific applications can be supplied, contact distributor for details.

FEATURES AND FUNCTIONS



FIGURE 1 – Tool Features

Brushless motor for low maintenance

Trigger and 'safe to start' button, if fitted, to ensure hands are safely positioned

High powered LED light to illuminate application

18V, 5.0Ah battery and efficient motor give outstanding fastening performance per charge

OLED display ensures visibility in all conditions

Key Lock feature prevents unauthorised usage

Tool is uninhibited by power cable or hose, improving safety, convenience and versatility

Multiple units of torque measurement, including N·m, lbf·ft, ft·lb and kgf·m

Torque, Torque & Angle with Final Torque and Torque Audit mode targets available

Display and on-board storage of Final Torque or Torque & Angle values

2500 reading memory, time and date stamped

Two modes of operation:

1. 'Torque only' is the default mode for the first-time user; only torque targets can be set and data storage / transfer is limited
2. 'Advanced' allows angle targets and full data storage / transfer

Sleep feature to turn off display to save battery power; default time 20 seconds

Clear indication of successful joint application

Data transfer options include wired USB or wireless Bluetooth® 4.0 (for connection to PC dongle) or G400

Complimentary EvoLog PC software for data management and tool configuration

12 user IDs can be downloaded to the tool and results can be stored against individual users

20 stand-alone targets, plus 5 work groups each containing up to 20 targets

Ability to produce and store real time graphs via EvoLog Software

'Usage' counter gives the ability to see the amount of times the tool has been used since the last reset

'Operation Direction' feature designed primarily for undoing bolts. When doing sequence tightening, it is now possible to undo an incorrectly tightened bolt without interrupting the sequence

'Turn Angle' measures bolt rotation to detect if bolt was already tight

'User' output format for tool integration into third party control systems

Tool models with 2 speeds (for faster bolt rundown) and right-angle drive (for bolt access)



FIGURE 2 – User Interface Features

SET UP INSTRUCTIONS

NOTE: If the equipment is used in a manner not specified by the manufacturer, the protection provided by the equipment may be impaired.



WARNING: ALLOW THE TOOL TO EQUALISE TO THE AMBIENT TEMPERATURE / HUMIDITY BEFORE SWITCHING ON. WIPE OFF ANY MOISTURE BEFORE USE.

Please complete the set up in the order shown.

Battery

Only use EvoTorque® Battery Pack (EBP) battery with this tool.

1. Insert battery into tool handle until latch operates.
2. To remove battery press both side latch buttons and slide battery out.



FIGURE 3 – Insert & remove battery

It is recommended to remove the battery pack during tool set up.

Charge battery in separate EvoTorque® Battery Charger (CTC123 (60335)).



FIGURE 4 – Insert battery into charger

Torque Reaction

The reaction bar ensures all reaction forces are contained, so torque reaction is not passed back to the operator. Several reaction bar styles are available.

Fit reaction bar as detailed below.

Reaction Bar Type	Fitting Instructions
Cranked Reaction Bar (Standard)	Fit reaction bar / plate over the drive square to engage reaction splines. Secure with circlip supplied.
Single Sided Reaction Plate (Optional)	
Double Sided Reaction Plate (Optional)	
Nose Extension (Optional)	Fit as per instructions supplied with nose extension.



FIGURE 5 – Nose Extension

It is essential the reaction bar rests squarely against a solid object or surface adjacent to the fastener to be tightened.

DO NOT react on the surface circled in red on figure 6.

React on the end of the reaction bar, circled in green on figure 6, using the maximum area possible.



FIGURE 6 – Cranked Reaction Bar (Steel or Aluminium)

The ideal reaction arrangement has the centre of the reaction bar and the centre of the nut on a perpendicular line to the centre line of the tool, see Figure 7.

The supplied reaction bar has been designed to give an ideal reaction point when used with a standard length socket.

To allow for a small difference in socket length the reaction bar may contact any point within the shaded area of Figure 7.

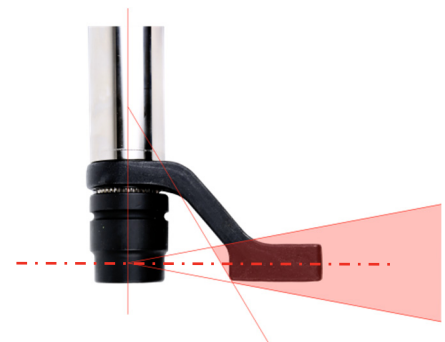

FIGURE 7 – Standard Length Socket Safe Reaction Window



WARNING: IF THE REACTION POINT IS OUTSIDE THE SHADED AREA EXCESSIVE LOADS MAY BE PLACED ON THE TOOL LEADING TO POTENTIAL OPERATOR INJURY AND DAMAGE TO THE TOOL.

If an extra long socket is used it may move the reaction bar outside the safe reaction window, as seen in Figure 8.

The standard reaction bar may need to be extended to ensure it remains within the shaded area.

For alternative reaction bars see ACCESSORIES list.



WARNING: IF MODIFYING THE STANDARD REACTION BAR, ENSURE IT IS CAPABLE OF TAKING THE MAXIMUM LOAD OF THE TOOL. FAILURE OF THE REACTION BAR CAN ENDANGER OPERATOR SAFETY AND DAMAGE THE TOOL.



FIGURE 8 – Extra Long Socket Safe Reaction Window

Long drive square extensions, see Figure 9, MUST NOT be used as these will cause serious damage to the tool output drive.

A range of nose extensions is available for applications where access is restricted. These are designed to support the final drive correctly.



FIGURE 9 – Drive Square Extension

The dimensions of the standard reaction bars are shown in the following table:



Steel Reaction Bar (Supplied)	Dimensions (mm)					
	Tool	'L'	'A'	'B'	'W'	'SQ'
	EBT-52	59	131	71	35	3/4"
	EBT-72	77	167	124	29	3/4" or 1"
	EBT-92	75	175	125	29	1"
	EBT-119	95	210	161	35	1 1/2"

FIGURE 10 – Reaction Bar

Nose Extension for Truck and Bus Wheels (Optional Accessory)	Dimensions (mm)						
	L	A	B	C	ØD	ØE	SQ
	98	47	132.5	29	52	38	3/4" or 1"

FIGURE 11 – Nose Extension for Truck and Bus Wheels

When the EBT is in operation the reaction bar rotates in the opposite direction to the output drive square and must be allowed to rest squarely against a solid object or surface adjacent to the fastener to be tightened. (See Figures 12 – 15).

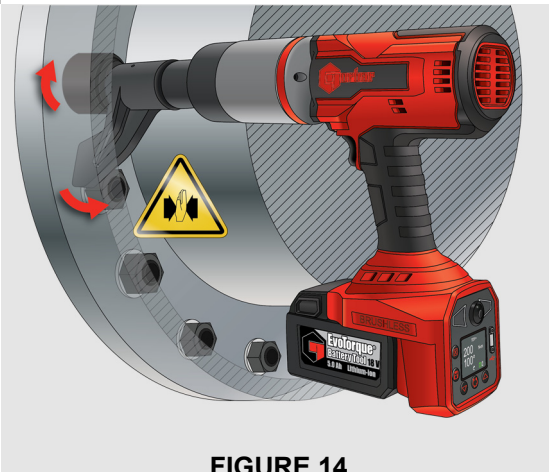
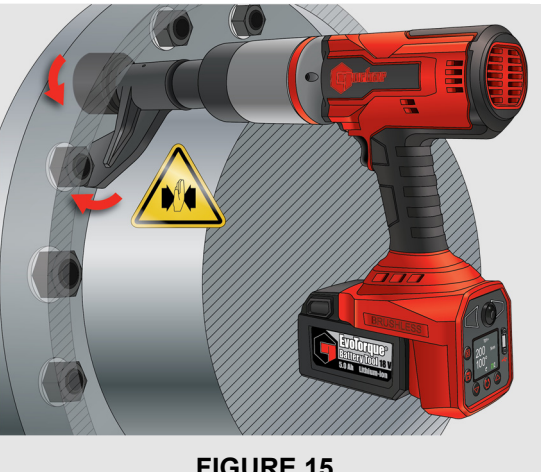



EBT Type	Torque Reaction	
	Clockwise	Counter – Clockwise
Example of EBT Tool	 <p>FIGURE 12</p>	 <p>FIGURE 13</p>
	 <p>FIGURE 14</p>	 <p>FIGURE 15</p>



WARNING: ALWAYS KEEP HANDS CLEAR OF THE REACTION BAR WHEN THE TOOL IS IN USE OR SERIOUS INJURY MAY RESULT.



Display Features



Button	Action
	Exit / Setting menu
	Select menu & increase / decrease value TIP: Keep button pressed for fast value change
	Accept / Direction
	Save / no save

If locked padlock appears, enter PIN code.
Any default value is shown as the first option.

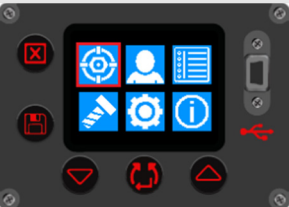





Setting Menu

Settings Menu	Detail	Action
	If the setting menu has 3 icons the MODE is set to "Torque only". This is the default setting menu.	Follow "(i) MODE Torque only"
	If the setting menu has 6 icons the MODE is set to "Advanced".	Follow "(ii) MODE Advanced"

(i) MODE Torque only:

Setting	Icon	MODE Torque only
Targets		Select Target # (T01 – T20). Set target torque.
Settings		Unit (N·m, lbf·ft, ft·lb or kgf·m) Auto Reset (✘ = Manual Reset / ✔ = Auto Reset). Time & Date (hh:mm:ss dd – mm – yy) Operation Direction ("⤵+⤴" = clockwise target + anti-clockwise target, "⤴" or "⤵" sets full torque in opposite direction for undoing fasteners) Mode (Torque only / Advanced) Sleep Time 20 sec (Off to 10 - 300 sec)
Information		Tool capacity, Time & date. Tool serial #, Tool name. Software version [D=Display, M=Motor & B=Bluetooth]. Error Log. Tool Statistics. Tool usage.

(ii) MODE Advanced:

Setting	Icon	MODE Advanced
Targets		Select Target # (T01 – T20). Set target torque. Set target angle (0 = no angle). Set final torque (0 = not enabled). Audit mode '✘' or '✔'? Set angle limit (for Audit mode) = 5° (2° to 720°).
Work Groups & Work IDs		Tracks the work done. See EvoLog PC software to add work groups.
User ID.		Tracks who is using the tool. See EvoLog PC software to add users.
Settings		Unit (N·m, lbf·ft, ft·lb or kgf·m) Auto Reset (✘ = Manual Reset / ✔ = Auto Reset). Lock (Off = Unlocked. 1 = Tool settings, Erase results & Target adjustment locked. 2 = Run screen with no multiple Targets locked). The PIN code set 0000 to 9999 [default 5000] TIP: Keep a note of the pin code in a safe place TIP: Lock 2 needs PC software to unlock. Wireless Comms? (✘ = OFF / ✔ = ON) Time & Date (hh:mm:ss dd – mm – yy) Tolerances (Torque 3% [range 3 – 20], Angle 2° [range 2 – 20], Turn > 0° [range 0 – 99]). Output Format (USER = CSV output for custom use / EVOLOG for EvoLog PC software) 2 Stage Target (✘ = Snug with angle / ✔ = Snug stage + Angle stage) Operation Direction (“⌚+⌚” = clockwise target + anti-clockwise target, “⌚” or “⌚” sets full torque in opposite direction for undoing fasteners) Mode (Torque only / Advanced) Sleep Time 20 sec (Off to 10 - 300 sec)
View Results		View results & Erase all. For more data control use EvoLog PC software.
Information		Tool capacity, Time & date. Tool serial #, Tool name. Software version [D=Display, M=Motor & B=Bluetooth]. Error Log. Tool Statistics. Tool usage.

OPERATING INSTRUCTIONS



WARNING: KEEP HANDS CLEAR OF THE REACTION BAR.



WARNING: WHEN USING THIS TOOL IT MUST BE SUPPORTED AT ALL TIMES IN ORDER TO PREVENT UNEXPECTED RELEASE IN THE EVENT OF FASTENER OR COMPONENT FAILURE.

Tightening

1. Fit the tool with required impact or high-quality socket. Slide the socket over the tool square drive ensuring the pin hole in both socket and square drive line up. Insert holding pin through the hole and place the retaining ring over the holding pin to secure.



FIGURE 16 – Fixing socket

2. Ensure the Clockwise/Counter-clockwise display arrow is correct.

Press  to change direction (if required).

3. Ensure Torque, Torque & Angle or Audit Torque target shown is correct.

Torque

Torque is applied until the target torque is reached.

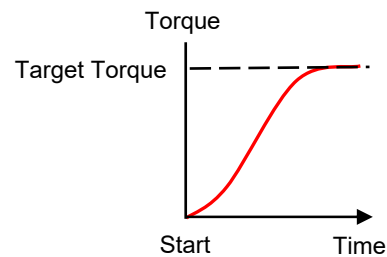

Torque & Angle

The tool applies the target torque (snug torque) followed by the target angle.

With 'Final Torque' enabled, a torque result at the target angle is known.

With '2 Stage Target' enabled, the 1st stage applies the Torque then 2nd stage applies the Angle. Release the trigger between stages.

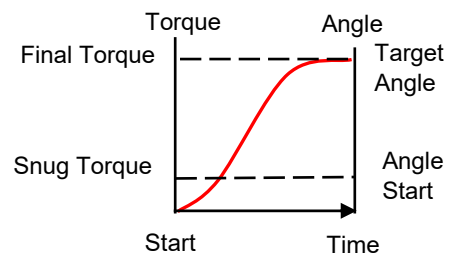

Audit Torque

Audit Torque is intended for checking tight bolts.

The tool runs slower.

Torque is applied until the target torque is reached.

The angle result is the angle moved by the fastener.

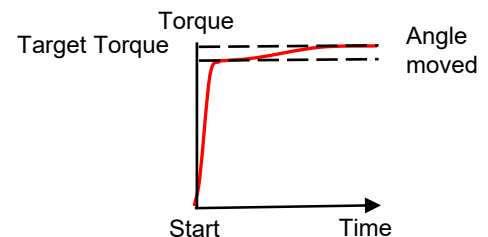

4. Rotate the handle into a convenient position relative to the reaction bar.
Fit the tool onto the fastener to be tightened with the reaction bar adjacent to the reaction point. See figure 17.
5. Adopt a posture to counteract normal or unexpected movement of the tool due to reaction forces.
6. Press trigger (and 'safe to start' button, if fitted, within 0.5 seconds) to slowly bring reaction bar into contact with the reaction point.
The 'safe to start' button is only required to start the tool, not for continued running.



FIGURE 17 – Clockwise Operation

NOTE: Bringing into contact at speed can lead to increased operator danger, fastener damage, reaction point damage and torque inaccuracies especially on high torque rate joints.

7. Fully press trigger (and 'safe to start' button if fitted), keep trigger fully pressed until tool stops, then release trigger.
8. Joint complete. See colour of displayed value for pass / fail status

Target	Torque	Torque & Angle	Audit Torque
Typical display			
Comment	Torque Target result (shown as red for fail)	Torque & Angle target (with Final Torque) result (shown as green for pass)	Audit Torque target result (showing achieved torque and output (bolt) movement in degrees)

9. Remove the tool from the fastener.

TIP: When tightening multiple fasteners on a flange it is recommended to mark each fastener when tight.



The Turn Angle setting can be used as a means of identifying an already tightened fastener.

This is even more important when using the TORQUE & ANGLE target as applying additional angle to a tightened fastener will increase the risk of operator danger, fastener damage and flange damage.

Saving Results

Auto Reset = Button Operation (after a successful tightening)

x

Press either the  or  buttons to Save the displayed (joint complete) reading and reset the tool, ready for the next tightening operation.

Press the  button to reset the tool ready for the next tightening operation **without** saving the (joint complete) reading.

✓

Press the  button to toggle between Save and No Save.

When the Save icon  is displayed, the next displayed (joint complete) reading will be saved and automatically reset the tool ready for the next tightening operation after the 'Hold Time' setting has expired.

The next displayed (joint complete) reading will **not** be saved if the icon is not shown.

NOTE: The Save icon will be shown in red when the tool is in 'Logging' mode. See *EvoLog PC software Operator's Manual (part number 34427)* for more details.

Releasing

1. Fit the tool with required impact or high-quality socket. Slide the socket over the tool square drive ensuring the pin hole in both socket and square drive line up. Insert holding pin through the hole and place the retaining ring over the holding pin to secure.



FIGURE 18 – Fixing socket

2. Ensure the clockwise/counter-clockwise display arrow is correct.

Press  to set direction.

3. Rotate the handle into a convenient position relative to the reaction bar.
Fit the tool onto the fastener to be released with the reaction bar adjacent to the reaction point. See figure 19.
4. Adopt a posture to counteract normal or unexpected movement of the tool due to reaction forces.
5. Press trigger (and 'safe to start' button if fitted) to slowly bring reaction bar into contact with the reaction point.
The 'safe to start' button is only required to start the tool, not for continued running.
6. Fully press trigger (and 'safe to start' button if fitted) and keep trigger fully pressed until the threaded fastener releases.

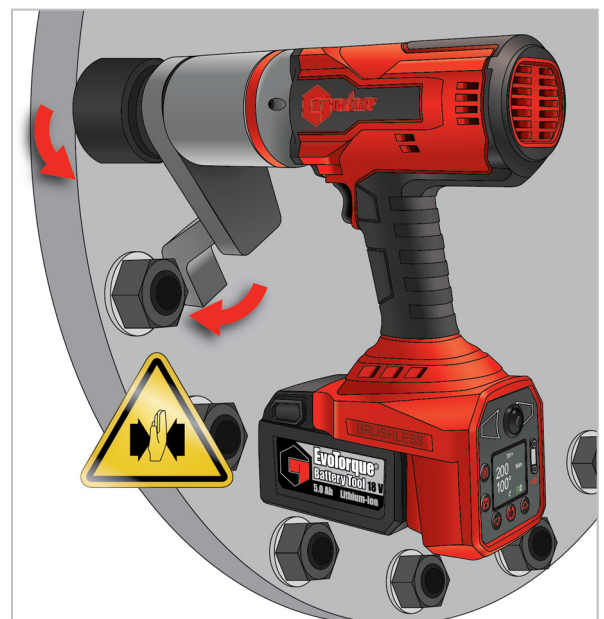

FIGURE 19 – Anti-Clockwise Operation

TIP: If unable to release the fastener, increase the target torque. The tool will automatically limit itself to the maximum output torque.

MAINTENANCE

For optimum performance and safety, regular tool maintenance is required. The user maintenance is limited to that stipulated in this section. Any other maintenance or repairs should be carried out by Norbar or a Norbar distributor. After any repair not covered in this section a recalibration must be completed.



WARNING: THE TOOL FEATURES A LITHIUM BATTERY. ALL LITHIUM BATTERIES ARE SUBJECT TO TRANSPORT LIMITATIONS WITH STRICT PACKAGING AND LABELLING CONDITIONS. TOOLS MAY BE EASIER TO RETURN WITHOUT THE LITHIUM BATTERY. ASK NORBAR OR A NORBAR DISTRIBUTOR BEFORE RETURNING TOOL.

Maintenance intervals will depend on the tool usage and the environment in which it is being used. The maximum recommended maintenance and recalibration interval is 12 months.

TIP: Steps the user can take to reduce the amount of maintenance required include:

- 1. Use the tool in a clean environment**
- 2. Maintain the correct torque reaction**
- 3. Carry out daily checks**

The tool has no user serviceable parts inside.



WARNING: REMOVE THE BATTERY PACK FROM THE TOOL BEFORE INVESTIGATING ANY FAULT. SHORT-CIRCUITING THE BATTERY PACK CAN CAUSE FIRE OR PERSONAL INJURY.

Daily Checks

- It is recommended to check the overall condition of the tool, battery & charger every day.
- Check for damaged parts and repair before use.
- Free run tool to ensure motor and gearbox are smooth and quiet.
- Run tool to ensure controls are operational.
- Check charger power cord for damage – replace if faulty.
- Ensure charger PAT test is within date.
- Maintain tools. Keep tools dry, clean and free of oil and grease - DO NOT use abrasives or solvent based cleaners.
- Ensure ventilation slots are clean and dust free. If cleaned with compressed air wear eye protection.

Calibration

The tool was supplied with a certificate of calibration. To maintain the specified accuracy, it is recommended that the tool is recalibrated at least once per year.

Recalibration should be carried out by a distributor with the facilities and traceability to perform a calibration. Do not remove tool casing; there are no calibration settings inside.

Gearbox

Under normal operating conditions it is not necessary to re-grease the gearbox. The gearbox contains Lubcon Turmogrease Li 802 EP.

Drive Square

If the tool is subject to torque overload there is potential for catastrophic tool damage. To reduce this risk the output drive square has been designed, like a fuse, so it will shear first. The output drive square is easy and quick to replace, for part numbers see ACCESSORIES listed in the INTRODUCTION. The drive square is NOT covered by the standard product warranty.

To replace the drive square:

1. Remove battery.
2. Support tool in a horizontal position
3. Use 4 mm hex key (supplied) to remove the screw and then remove drive square. If the square has sheared it may be necessary to use pliers to remove the broken parts.



FIGURE 20 – Drive square removal

Battery Maintenance

Refer to EBP Operator's Manual (Part #34466).

If the battery does not hold charge it should be replaced. The old battery should be disposed of correctly.

Battery Charger Maintenance

Refer to CTC123 (60335) Operator's Manual (Part #34468).

Product Disposal





This symbol on the product indicates that it must not be disposed of in the general waste.

Please dispose of according to your local recycling laws and regulations. Contact your distributor for further recycling information.

SPECIFICATIONS

NOTE: Due to continuous improvement, all specifications are subject to change without prior notice.

Symbol Specifications

Symbol	Meaning
	REFER TO OPERATORS MANUAL
V	Volt
— — —	Direct current
	CE mark
	DO NOT THROW IN GENERAL WASTE

Tool Specifications

Model	Torque	Max Tool Speed Free Running*
	Calibrated Range	
EBT-800 Single Speed	160 N·m – 800 N·m	11.2 rpm
EBT-1350 Single Speed	200 N·m – 1,350 N·m	6.5 rpm
EBT-1350 Auto Two Speed	338 N·m – 1,350 N·m	32 rpm
EBT-2700 Single Speed	400 N·m – 2,700 N·m	3.3 rpm
EBT-2700 Auto Two Speed	676 N·m – 2,700 N·m	13 rpm
EBT-4000 Single Speed	800 N·m – 4,000 N·m	2.3 rpm
EBT-4000 Auto Two Speed	1000 N·m – 4,000 N·m	9.5 rpm

* = Tool speed is reduced for Audit mode.

Model	Tool Weight (kg)*	Battery Weight (kg)	Reaction Weight (kg)	Bare tool in cardboard case (kg)**	Kit tool in plastic case (kg)***
EBT-800 Single Speed	3.7	0.8	0.85	6.9	14.9
EBT-1350 Single Speed	5.7	0.8	1.7	8.9	16.9
EBT-1350 Auto Two Speed	5.9	0.8	1.7	9.1	17.1
EBT-2700 Single Speed	5.9	0.8	1.7	9.1	17.1
EBT-2700 Auto Two Speed	6.8	0.8	1.7	10.0	18.0
EBT-4000 Single Speed	7.9	0.8	2.5	11.9	19.9
EBT-4000 Auto Two Speed	8.3	0.8	2.5	12.3	20.3

* = Tool weight excludes both reaction and battery.

** = Tool weight is for In-Line gearbox (for Right Angle gearbox add 2.1 kg). Reaction included. Battery & Secondary Handle NOT included.

*** = Tool + 2 Batteries + Battery Charger. Tool weight is for In-Line gearbox (for Right Angle gearbox add 2.1 kg). Reaction and Secondary Handle included.

Model	Dimensions (mm)											
	ØD	H1	H2	H3*	H4*	L*	L1	L2	R1	R2 min	R2 max	W
EBT-800	52	40	262	171 (-)	28	271 (-)	269	235	59	68	131	90
EBT-1350	72	40	262	198 (217)	28	298 (317)	269	235	76	124	167	90
EBT-2700	80	40	262	191 (226)	28	298 (333)	269	235	76	124	167	90
EBT-4000	92	40	262	250 (285)	28	352 (387)	269	235	70	125	175	92

* = Length for 1 speed (length for 2 speed).

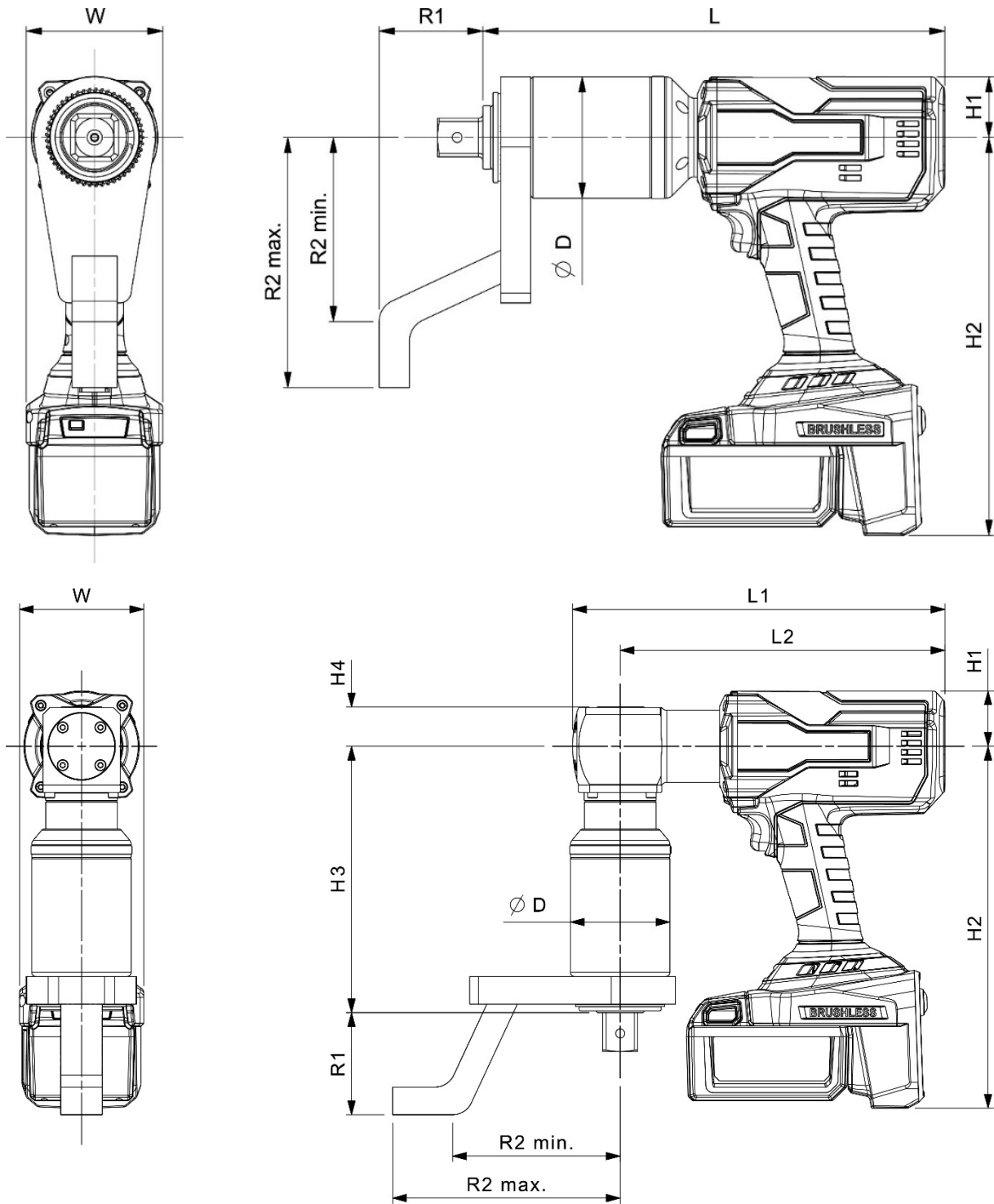

FIGURE 21 – Tool Dimensions

Angle Setting:	10° to 720°
Angle Start Threshold:	10% to 100% of tool capacity
Display:	Colour OLED (160 x 128 pixels)
Motor Voltage:	18.0 VDC
Memorised readings:	2500
Vibration emission:	The vibration total value does not exceed 2.5m/s ² Measured tool vibration (ah) = 0.9 m/s ² with uncertainty K = 0.22 m/s ²
Noise emission:	Sound Pressure Level, L _{pA} = 79.1 dB(A) uncertainty K = 3dB

The declared vibration and noise emission values have been measured in accordance with a standard test method and may be used for comparing one tool with another.

The declared vibration and noise emission values may also be used in a preliminary assessment of exposure.



WARNING: THE VIBRATION AND NOISE EMISSIONS DURING ACTUAL USE OF THE POWER TOOL CAN DIFFER FROM THE DECLARED VALUES DEPENDING ON THE WAYS IN WHICH THE TOOL IS USED ESPECIALLY WHAT KIND OF WORKPIECE IS PROCESSED.



WARNING: IDENTIFY SAFETY MEASURES TO PROTECT THE OPERATOR THAT ARE BASED ON AN ESTIMATION IN THE ACTUAL CONDITIONS OF USE (TAKING ACCOUNT OF ALL PARTS OF THE OPERATING CYCLE SUCH AS THE TIMES WHEN THE TOOL IS SWITCHED OFF AND WHEN IT IS RUNNING IDLE IN ADDITION TO THE TRIGGER TIME).

Environment:	Industrial. Store in a clean and dry environment
Temperature Range:	-20°C to +49°C (operating). -20°C to +49°C (storage)
Operating Humidity:	85% Relative Humidity @ 30°C maximum
USB:	2.0
Bluetooth®:	Bluetooth® Smart 4.0 for use will USB smart adaptor supplied "Contains Transmitter Module FCC ID: QOQBLE112" "Contains Transmitter Module IC: 5123A-BGTBLE112" Frequency: 2.402 GHz to 2.480 GHz Maximum power transmitted: +3dBm to -23dBm Wireless range tested to 6m. Can work over 20m in an ideal environment
G400 (XBee):	"Contains Transmitter Module FCC ID: MCQ-XBS2C" "Contains Transmitter Module IC: 1846A-XBS2C" Frequency: 2.405 GHz to 2.480 GHz Maximum power transmitted: 12.65mW (11.02 dBm) EIRP Wireless range tested to 6m. Can work over 20m in an ideal environment

USB BLUETOOTH® SMART ADAPTOR SPECIFICATION (WHERE INCLUDED)



FCC and IC

This equipment has been tested and found to comply with the limits for a Class B digital device, pursuant to Part 15 of the FCC Rules. These limits are designed to provide reasonable protection against harmful interference in a residential installation.

This equipment generates, uses and can radiate radio frequency energy and if not installed and used in accordance with the instructions, may cause harmful interference to radio communications. However, there is no guarantee that interference will not occur in a particular installation. If this equipment does cause harmful interference to radio or television reception, which can be determined by turning the equipment off and on, the user is encouraged to try to correct the interference by one of the following measures:

- Reorient or relocate the receiving antenna
- Increase the separation between the equipment and receiver
- Connect the equipment into an outlet on a circuit different from that to which the receiver is connected
- Consult the dealer or an experienced radio/TV technician for help

FCC Caution : To assure continued compliance, any changes or modifications not expressly approved by the party responsible for compliance could void the user's authority to operate this equipment. (Example - use only shielded interface cables when connecting to computer or peripheral devices).

FCC Radiation Exposure Statement

This equipment complies with FCC RF radiation exposure limits set forth for an uncontrolled environment. This device complies with Part 15 of the FCC Rules. Operation is subject to the following two conditions:

1. This device may not cause harmful interference, and
2. This device must accept any interference received, including interference that may cause undesired operation.

Industry Canada

IC Statements:

This device complies with Industry Canada licence-exempt RSS standard(s). Operation is subject to the following two conditions: (1) this device may not cause interference, and (2) this device must accept any interference, including interference that may cause undesired operation of the device.

Under Industry Canada regulations, this radio transmitter may only operate using an antenna of a type and maximum (or lesser) gain approved for the transmitter by Industry Canada. To reduce potential radio interference to other users, the antenna type and its gain should be chosen so that the equivalent isotropically radiated power (e.i.r.p.) is not more than that necessary for successful communication.

Déclaration d'IC :

Ce dispositif est conforme aux normes RSS exemptes de licence d'Industrie Canada. Son fonctionnement est assujéti aux deux conditions suivantes : (1) ce dispositif ne doit pas provoquer de perturbation et (2) ce dispositif doit accepter toute perturbation, y compris les perturbations qui peuvent entraîner un fonctionnement non désiré du dispositif.

Selon les réglementations d'Industrie Canada, cet émetteur radio ne doit fonctionner qu'avec une antenne d'une typologie spécifique et d'un gain maximum (ou inférieur) approuvé pour l'émetteur par Industrie Canada. Pour réduire les éventuelles perturbations radioélectriques nuisibles à d'autres utilisateurs, le type d'antenne et son gain doivent être choisis de manière à ce que la puissance isotrope rayonnée équivalente (P.I.R.E.) n'excède pas les valeurs nécessaires pour obtenir une communication convenable.

CE

USB Bluetooth® Smart adapter is in conformity with the essential requirements and other relevant requirements of the RED Directive (2014/54/EU).

South-Korea

USB Bluetooth® Smart adapter is certified in South-Korea with certification number: KCC-CRM-BGT-BLED112

Japan

USB Bluetooth® Smart adapter has MIC Japan type certification with certification number: 003WWA111471

Brazil



Este equipamento opera em caráter secundário, isto é, não tem direito à proteção contra interferência prejudicial, mesmo de estações do mesmo tipo e não pode causar interferência a sistemas operando em caráter primário.



Norbar Torque Tools Ltd

Wildmere Road | Banbury | Oxfordshire | OX16 3JU | UK
T +44 (0)1295 270333 | F +44 (0)1295 753643
E enquiry@norbar.com | www.norbar.com

QA57
ISSUE 2
24.1.97

EU Declaration of Conformity (No 0027.2)

This declaration of conformity is issued under the sole responsibility of the manufacturer.

The object of the declaration:

EvoTorque® Battery Tool:
Model names EBT-52-800
EBT-72-1350
EBT-80-2700
& EBT-92-4000
Part Numbers 180349 to 181089



The object of the declaration described above is in conformity with the relevant union harmonisation legislation:

Directive 2006/42/EC on Machinery Directive.
Directive 2014/30/EU on Electromagnetic Compatibility.
Directive 2014/53/EU on Radio Equipment.
Directive 2011/65/EU of the European Parliament and of the Council of 8 June 2011 on the restriction of the use of certain hazardous substances in electrical and electronic equipment (RoHS).

The object of the declaration described above has been designed to comply with the following standards:

EN 62841-1:2015 & EN 62841-2-2:2014
EN 55014-1:2017 & EN 55014-2:2015
EN 61000-3-2:2014 & EN 61000-3-3:2013
EN 301 489-1 v.2.1.1, EN 301 489-17 v3.1.1 & EN 300 328 v2.1.1

The basis on which conformity is being declared:

The technical documentation required to demonstrate that the products meet the requirements of the above Directives has been compiled by the signatory below and is available for inspection by the relevant enforcement authorities.

The CE mark was first applied in: 2019.

The authorised representative within the European Union (EU) is:



Francesco Frezza Snap On Equipment Via Prov. Carpi, 33 42015 Correggio RE Italy

Signed for and on behalf of Norbar Torque Tools Ltd.

Signed: *T. M. Lester* **Full Name:** Trevor Mark Lester B.Eng.
Date: 22 September 2020 **Authority:** Compliance Engineer
Place: Norbar Torque Tools Ltd., Wildmere Road, Banbury, Oxfordshire. OX16 3JU

TROUBLESHOOTING

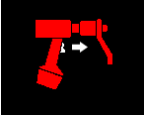
The following is only a guide, for more complex fault diagnoses please contact your distributor.

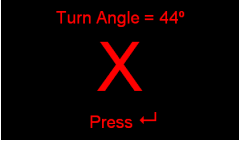
Problem	Likely Reason	Likely Solutions
No Display	Sleep time active Flat battery	Pull trigger to wake up tool Change / charge battery
Tool output drive does not rotate when trigger is pressed	'safe to start' button NOT pressed	Press trigger + 'safe to start' button at the same time (within approximately half a second) to run tool
	Tool is on tight fastener	Remove from fastener Check correct setting of tool direction
	Tool is off	Ensure tool is ON (display lit)
	Tool is in set up screen	Exit set up to return to operate screen
	Output drive square sheared	See MAINTENANCE section to replace drive square
	Gear train or motor is damaged	Contact distributor
Result shown in Red	Bolt has not made correct torque or angle	Trigger released early  Fastener sheared or thread stripped
Measured angle is less than tool applied	Flex in reaction bar or reaction point	Ensure reaction bar & reaction point are rigid
E>1350, E>2700, E>4000	Demand for torque greater than tool capacity	Use larger capacity tool
Tool runs slower at lower Targets or in Audit mode	Normal operation	Normal operation
	Slam joint. a) The reaction bar is moving too fast (tightening)	Undo and re-tighten the joint
	b) Un-doing a tightened joint with too low a Target	Use a larger Target value than the tightening Target
Not working with PC software	Output Format has been set to USER	Change the Output Format to PC software
Lost PIN number	Contact distributor	
Battery symbol shown in power up	Low time/date battery. Contact distributor	
	a) Turn Angle set too High	Decrease Turn Angle setting
	b) Joint already tight	
Tool stops, with 4 flashing LED's on battery	Battery over temperature, 158°F (70° C) detected	Wait for battery to cool Place battery on charger to take advantage of charger cooling fan
Tool stops, with left battery LED flashing	Battery voltage low	Charge battery
Tool Error Release Trigger	A fault has occurred, please release both of the triggers.	Release both triggers.

Problem	Likely Reason	Likely Solutions
FWD/REV Signal Error	M.C.U. has not received a direction signal.	Release both triggers. If problem persists, contact Norbar.
Motor Over Temperature	Motor too hot.	Wait for the motor to cool.
M.C.U. Over Temperature	Motor Control Unit too hot.	Wait for the motor control unit to cool.
MOSFET Over Temperature	MOSFET in motor power circuitry too hot.	Wait for the MOSFET circuitry to cool.
Over Voltage Error	Battery voltage exceeds 22V.	Remove the current battery, before connecting a fully-charged battery to the tool. If problem persists, contact Norbar.
Under Voltage Error	Battery voltage has fallen below 13V during bolting operation.	Remove the current battery, before connecting a fully-charged battery to the tool. If problem persists, contact Norbar.
Short Circuit Protection	An electrical short has been detected between the battery and the M.C.U..	Release both triggers. If problem persists, contact Norbar.
Phase Open Protection	Motor Control Unit is unbalanced; it is not safe for the motor to start.	Disconnect, then re-connect the battery to the tool. If problem persists, contact Norbar.
Motor N.T.C. Open	Thermistor on motor is currently open circuit.	Disconnect, then re-connect the battery to the tool. If problem persists, contact Norbar.
MOSFET N.T.C. Open	Thermistor on MOSFET is currently open circuit.	Disconnect, then re-connect the battery to the tool. If problem persists, contact Norbar.
Hall Sensor Error	A connection or synchronization issue has occurred with the motor sensors.	Contact Norbar.
Low Voltage Start	Battery voltage is below 13V on trigger press.	Remove the current battery, before connecting a fully-charged battery to the tool.
Rotor Lock	Motor speed < 300 R.P.M. for 200ms or longer.	Release both triggers. If problem persists, contact Norbar.
Hard Current Limit	Motor current has exceeded safe level for 1-2 seconds.	Release both triggers. If problem persists, contact Norbar.
Torque Shutoff Before Angle	Tool is perceived to be operating beyond its safe capacity.	Operate tool within stated capacity only.
Tool Cannot Zero	Tool auto-zero process is unable to “zero” the transducer within the A.D.C. range.	Ensure that the transducer is electrically connected, and mechanically secured. Verify that the transducer has not been damaged/heavily deflected through usage beyond operational capacity.
Slam Joint Detection	Tool slammed into fastener.	Bring reaction bar slowly into position.
Battery Error	Flat Battery / Overheated Battery	Charge Battery / Allow Battery to cool
Battery Error	Battery connection fault	Contact Norbar
Battery charger right hand LED flashes yellow	Battery pack is either too hot or too cold	Wait for battery temperature to be between 32°F (0°C) and 113°F (45°C)
Battery charger right hand LED flashes red	Battery pack is faulty	Replace battery
Message “Mode2>>Mode1. No Torque Only Targets”	No torque only targets	Create a torque only target then change to MODE 1 (Torque Only)
Cannot set angle or output communications	In “Torque only” mode	Set Mode to “Advanced”

GLOSSARY OF TERMS

Word or Term	Meaning
A	Amps
Angle Limit	Maximum allowed angle movement in Audit mode
Audit	Checking a pre-tightened joint
Auto reset	Tool will automatically reset ready for the next tightening operation
a.c.	Alternating Current
A/F	Across Flats
Bi-directional	Clockwise and Counter Clockwise
CSV	Comma Separated Values
CTC123	EvoTorque® Battery Charger
EvoLog	PC software supplied with EBT (not for use with G400 tool)
EBP	EvoTorque® Battery Pack
EBT	EvoTorque® Battery Tool
Fastener	Bolt or stud to be tightened
Final Torque	Torque target: Torque value Torque & angle target: The torque when angle complete
G400	Tool for working with Sturtevant Richmond Global 400 wireless error proofing system. When in use “G4” will appear on EBT display. “G4” is shown in red when not connected and green when connected
Nose Extension	A reaction type used where tool access is restricted, a typical example is on wheel nuts on heavy vehicles
PPE	Personal Protective Equipment
Reaction Bar	Item to counteract applied torque. Also called Reaction Plate
Record	A memory location. A Work Group, Work ID, User ID or Result saved in the tools memory
RCD	Residual Current Device, for disconnecting the electrical supply in the case of a fault; so protecting the operator A device with a trip value of 30mA or less is recommended
Target	The Torque, Torque & Angle or Audit Torque that the tool is set to
Safe to start	Tool with second trigger button so both hands are located on the tool
Single Trigger	Tool for applications where “Safe to start” feature is not practical
Snug	“Snug” refers to the torque applied for a Torque & Angle target
Torque Rate	The increase in torque with angular displacement while advancing a fastener in a threaded joint (as defined in ISO 5393 Rotary Tools for Threaded Fasteners – Performance Test Method.) A LOW torque rate is often referred to as a SOFT joint A HIGH torque rate is often referred to as a HARD joint
Turn Angle	Minimum angle of rotation of a Torque only fastener
User ID	Identification of the person using the tool
V	Volt
Work ID	Identification of a group of Results
Work Group	Specific group of a number of Work IDs and Targets

**NORBAR TORQUE TOOLS LTD**

Wildmere Road, Banbury,
Oxfordshire, OX16 3JU
UNITED KINGDOM
Tel + 44 (0)1295 270333
Email enquiry@norbar.com

**NORBAR TORQUE TOOLS PTE LTD**

194 Pandan Loop
#07-20 Pantech Business Hub
SINGAPORE 128383
Tel + 65 6841 1371
Email enquires@norbar.sg

**NORBAR TORQUE TOOLS**

45-47 Raglan Avenue, Edwardstown,
SA 5039
AUSTRALIA
Tel + 61 (0)8 8292 9777
Email enquiry@norbar.com.au

**NORBAR TORQUE TOOLS (SHANGHAI) LTD**

91 Building- 7F, No. 1122, Qinzhou North Road,
Xuhui District, Shanghai
CHINA 201103
Tel + 86 21 6145 0368
Email sales@norbar.com.cn

**NORBAR TORQUE TOOLS INC**

36400 Biltmore Place, Willoughby,
Ohio, 44094
USA
Tel + 1 866 667 2279
Email inquiry@norbar.us

**NORBAR TORQUE TOOLS INDIA PVT. LTD**

Plot No A-168, Khairme Industrial Area,
Thane Belapur Road, Mahape,
Navi Mumbai – 400 709
INDIA
Tel + 91 22 2778 8480
Email enquiry@norbar.in

www.norbar.com