

ATTACHMENTS & ACCESSORIES

60322 - FMT Quick Release Kit allowing for a more streamlined and efficient calibration laboratory

60330 - Offset Angle Plate Kit allows for greater flexibility when calibrating fixed head torque wrenches

60318 - Static Transducer Support Kit & * **60319** - Short Length Reaction Post Assembly to calibrate small torque wrenches

60323 - Pro-Test and Static Torque Block Adaptor Kit

60327 - FMT 25 Adaptor Kit

29214 - Square Drive Adaptor 1" Male to 3/4" Female Flanged
29215 - Square Drive Adaptor 1" Male to 1/2" Female Flanged
29216 - Square Drive Adaptor 1" Male to 3/8" Female Flanged
29217 - Square Drive Adaptor 1" Male to 1/4" Female Flanged

60324 - Hexagon Adaptor Kit with 22mm hexagon shaft allows users to speed up the work-flow by implementing their own solution to rapidly manoeuvre the wrench up to the reaction point

* When using the Short Length Reaction Post the wrench will no longer be counterbalanced.

GLOBAL SERVICE

Norbar is the only torque equipment manufacturer capable of offering tool and instrument calibration services to the original factory standard on four continents.

Accredited laboratories in Australia, USA, Singapore, China and India operate the same equipment and procedures as the UKAS accredited laboratory within our headquarters in the UK.

 NORBAR TORQUE TOOLS LTD
 Wildmere Road, Banbury, Oxfordshire, OX16 3JU
 UNITED KINGDOM
 Tel + 44 (0)1295 753600
 Email sales@norbar.com

 NORBAR TORQUE TOOLS
 45-47 Raglan Avenue, Edwardstown
 SA 5039
 AUSTRALIA
 Tel + 61 (0)8 8292 9777
 Email enquiry@norbar.com.au

 NORBAR TORQUE TOOLS INC
 36400 Biltmore Place, Willoughby
 Ohio 44094
 USA
 Tel + 1 866 667 2272
 Email inquiry@norbar.us

 NORBAR TORQUE TOOLS PTE LTD
 194 Pandan Loop, #07-20 Pantech Business Hub
 SINGAPORE 128383
 Tel + 65 6841 1371
 Email enquires@norbar.sg

 NORBAR TORQUE TOOLS (SHANGHAI) LTD
 91 Building- 7F, No. 1122, North Qinzhou Road
 Xuhui District, Shanghai
 CHINA 201103
 Tel + 86 21 6145 0368
 Email sales@norbar.com.cn











 NORBAR TORQUE TOOLS INDIA PVT. LTD
 Plot No A – 168 Khairne Industrial Area
 Thane Belapur Road
 Mahape Navi Mumbai – 400 709
 INDIA
 Tel + 91 22 2778 8480
 Email enquiry@norbar.in

www.norbar.com



Part number 07589 | Issue 3

NORBAR PRODUCT PORTFOLIO

-  Torque Screwdrivers
-  Torque Wrenches
-  Electronic Torque Wrenches
-  Manual Torque Multipliers
-  Pneumatic Torque Tools
-  Electronic Torque Tools
-  Battery Torque Tools
-  Torque Measurement Instruments
-  Torque Transducers
-  Ultrasonic Bolt Measurement
-  Calibration Services

 **Let's Talk**
 The live chat feature can be found at the bottom right of any page on our website

Distributed by



TORQUE WRENCH CALIBRATOR

ENABLING TORQUE WRENCH TESTING AND CALIBRATION IN ACCORDANCE WITH ISO 6789-1:2017 AND ISO 6789-2:2017



THE TORQUE WRENCH CALIBRATOR (TWC) ENABLES TORQUE WRENCH TESTING AND CALIBRATION IN ACCORDANCE WITH ISO 6789-1:2017 AND ISO 6789-2:2017

Counterbalance reaction is designed to support the weight of the wrench so that the weight does not become a parasitic force within the calibration system. The floating nature of the support means that the wrench is able to find its own natural level rather than being constrained as in many other loading devices. Any such constraint will be a parasitic force within the system. (Patents apply)

Compatible transducers include Flange Mounted Transducers, Static Transducers (when using part number: 60318) and Pro-Test (when using part number: 60323)

Lightweight alloy construction ensures the TWC is easily transported, making it well suited for mobile laboratory applications

Enables torque wrench calibration or testing in accordance with ISO 6789-2:2017 if used with T-Box™ 2

T-Box™ 2 Instrument-43542 (not included)

Two-speed gearbox designed for a sufficient balance of speed and control by allowing for both fast loading of the torque wrench and a slower more precise loading (Manual version only)

Rotating transducer design ensures that the load is applied 90° to the torque wrench handle. The benefit of this precise alignment is that forces are applied squarely to the load point of the handle



TWC Manual shown with a Flange Mounted Transducer and a model 100 torque wrench (not included)



KEY ADDITIONAL FEATURES FOR AUTO VERSION

- Supplied with a powerful yet simple touchscreen User Interface (UI) (keyboard and mouse also supported if desired)
- Flexible tool template system; minimises number of templates required to cover a wide range of tools, aiding efficient use
- Programmable calibration workflow for each template, can be pre-set to ISO compliant flow for the given tool for a faster set-up or can also support bespoke workflows
- Calibration job management; book calibrations, track progress of previous bookings and resume them
- Automated management of calibration and conformance workflows for non-indicating tools
- Intelligent rate control system ensures fast cycling of tools while maintaining compliance with 2017 standards
- Environmental monitoring (humidity/temperature) to ensure compliance with calibration standards
- Automated management of uncertainty data for ISO 6789-2:2017 calibrations, guiding the user through the process using dynamically generated instructions based on the current tool's ISO classification and workflow
- Inbuilt data analysis and certification generation seamlessly move from calibration/conformance procedure to certificate generation, no third-party software required
- A substantial amount of inbuilt storage allowing for several years' worth of calibration data through normal use



Main menu



Tool template editor



Calibration job booking / editor



Tool cycling and adjustment



Tool cycling and adjustment whilst in operation

TECHNICAL SPECIFICATION		MANUAL		AUTO	
		400 N·m 295 lbf·ft	1500 N·m 1100 lbf·ft	400 N·m 295 lbf·ft	1500 N·m 1100 lbf·ft
Part Number		60331	60332	60312	60313
Wrench Length (Torque Radius)	Min	135	135	135	135
	Max	750	1500	750	1500
Dimensions	A	620	620	620	620
	B	330	330	330	330
	C	395	395	395	395
	D	487	487	N/A	N/A
	E	1010	1760	1019	1769
Weight (kg)		35	40	40	45

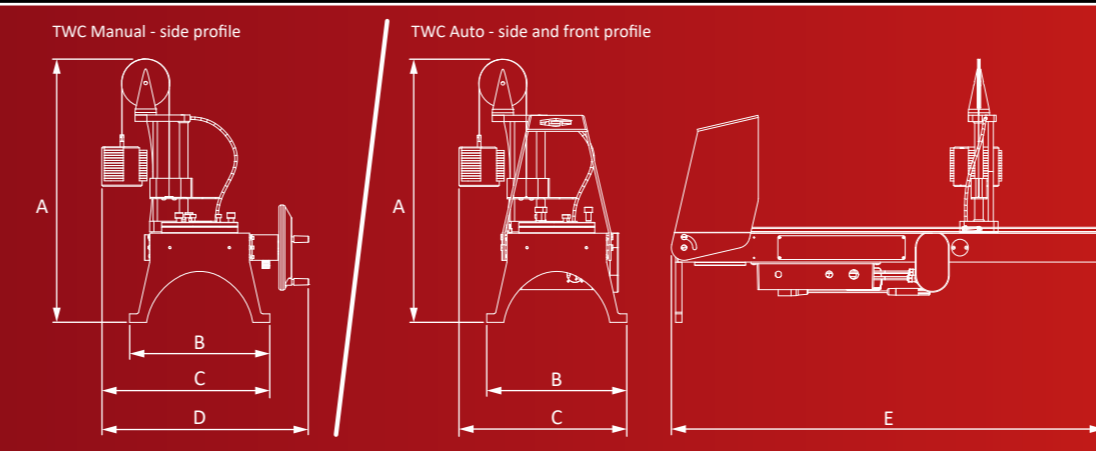

Patented in the UK, Germany, France and Italy (EP2864745) and in the USA (US9921122).

